



Application Guide

Vitodens 200-W B2HA,B2HB
Residential Boiler

Application Guide

The application examples contained in this document serve as a guideline only. These are not engineered drawings and are not intended to replace project designs provided by a professional engineer. It is the responsibility of the installing contractor to ensure all aspects of the system comply with the local authorities having jurisdiction.

© 2017 by Viessmann. All rights reserved.

No part of this book may be used or reproduced in any manner whatsoever without prior written permission.

For information, contact:

Viessmann Manufacturing Company Inc.

750 McMurray Road

Waterloo ON, N2V 2G5, Canada

Phone: 519-885-6300

Toll Free: 800-387-7373

www.viessmann.ca

The Viessmann logo consists of the word "VIESSMANN" in a bold, sans-serif font. The letter "S" is stylized, with a vertical line passing through its center, creating a unique graphic element.

Pre-Face / Overview

Each day Viessmann heating systems face a wide variety of requirements and challenges here in North America, and around the world. Whether in historically protected homes, modern commercial buildings, or in large facilities, Viessmann products meet every demand and offer solutions for all your needs: wood, oil, or gas fired boilers for both residential and commercial use, from 12KBTU to 17.9MMBH (4 to 5263kW), domestic hot water storage tanks, solar collectors, Biogas technologies, and much more.

Viessmann also sets the standard for operational reliability, operating comfort, environmental friendliness and a long service life. All Viessmann products have one thing in common: they are based on a modular

technology strategy with one common platform. This way, different product versions can be created to fulfill each customer's specific requirements. In short, Viessmann takes care of all your needs, from start to finish.

Part of that is a comprehensive support program: A knowledgeable Viessmann sales representative network, technical training academy, and technical support personnel assist you right from the planning stage through to the installation and start-up phase of a project.



With Viessmann you are witnessing intelligent, high-tech boiler technology at work. We have selected some of the most interesting Viessmann applications from across North America for your reference.

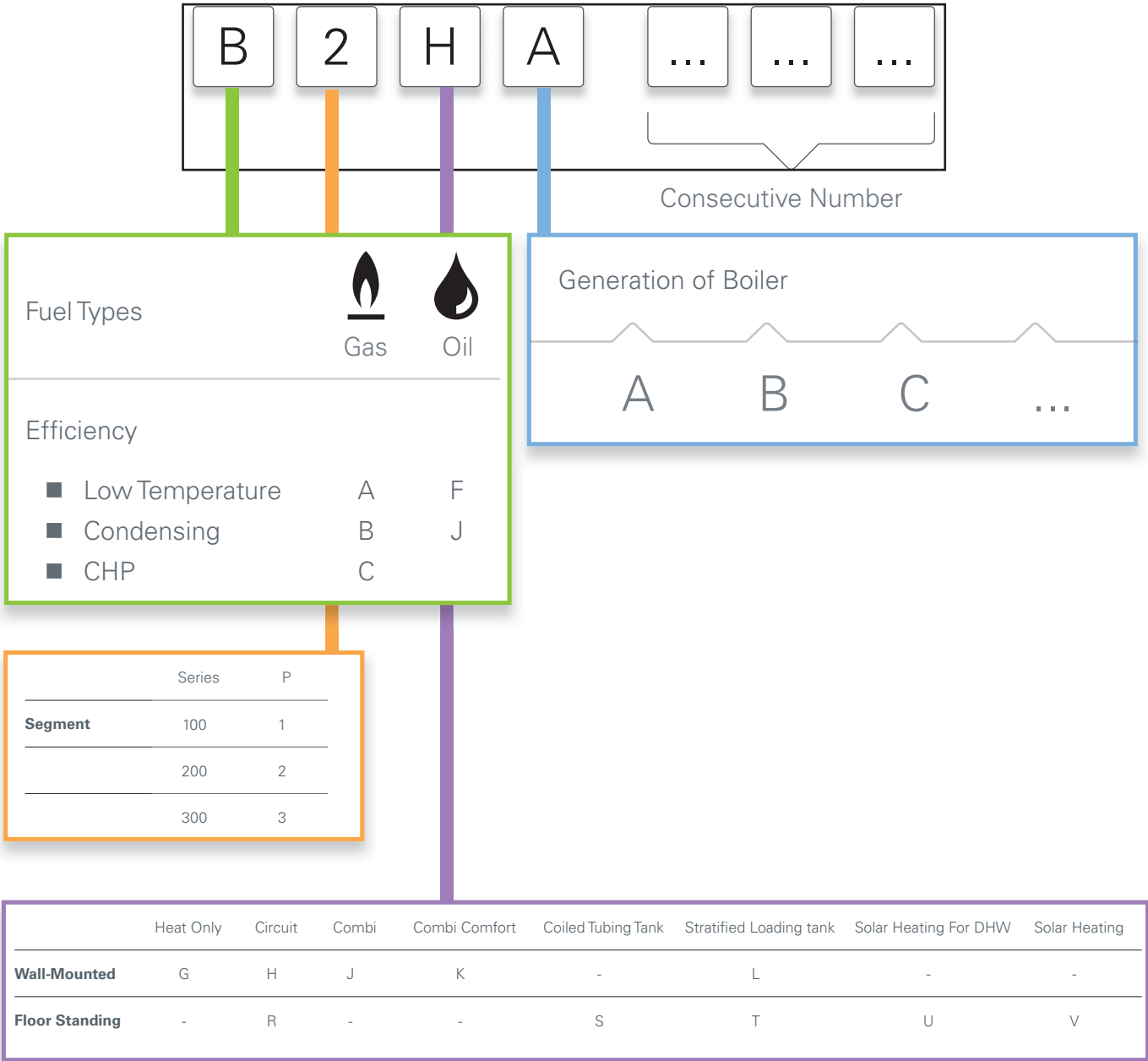

Identifying Boiler Nomenclature



Fuel Types

Gas  Oil 

Efficiency

■ Low Temperature	A	F
■ Condensing	B	J
■ CHP	C	

Generation of Boiler

A B C ...

	Series	P
Segment	100	1
	200	2
	300	3

	Heat Only	Circuit	Combi	Combi Comfort	Coiled Tubing Tank	Stratified Loading tank	Solar Heating For DHW	Solar Heating
Wall-Mounted	G	H	J	K	-	L	-	-
Floor Standing	-	R	-	-	S	T	U	V

Identifying Application Codes

2 VD 2 X

Number of boilers in system

Boiler Segment

VD	├	Vitodens
CU		
CM	├	Vitocrossal
CT		
VR	├	Vitorond

Segment / Series

1	100 Series
2	200 Series
3	300 Series

Domestic Capability

X	No DHW
I	With indirect DHW
C	On demand DHW
T	Stratified Loading Tank

I ZC 2 ZP 01

Number of heating circuits

1, 2, 3 ...

Type of Circuits:

HC	Heating Circuit
ZC	Zone Circuit
HC/ZC	Combination System

Number of individual zones in system

How system is zoned

ZP	Pumps
ZV	Zone Valves
TV	Thermostatic Radiator Valves
C	Combination

Drawing version

RECOMMENDED PRODUCT APPLICATIONS

Application	Typical Supply Temperature	Vitodens 100	Vitodens 200/222-F	Vitocrossal 300 CU3A	Vitorond 100
	High 160 -190 °F	◆ ¹	◆ ¹	★	★
	Medium 140 -160 °F	★	★	★	◆ ²
	Medium 120 -160 °F	★	★	★	◆ ²
	Low 80 -120 °F	★	★	★	●
	High 160 -190 °F	◆ ¹	◆ ¹	★	★
	Medium 120 -180 °F	★	★	★	★

★ **Best Choice**

◆ Possible with limitations

● Not recommended

1- Limited maximum boiler supply water temperature.

2- Ensure boiler protection to prevent against low return water temperature

Refer to Technical Data Manual of each product for applicable certifications. Technical information subject to change without notice.

Component Index

Hydronic Components

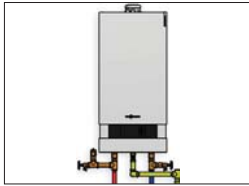

Vitodens 200 accessories kit with pressure relief and purge valves.

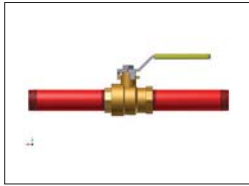

Ball valve



Circulator with isolation flanges

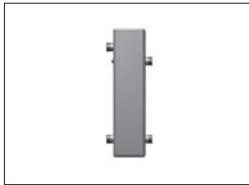

Low loss header

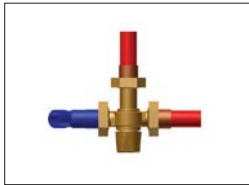

Thermostatic mixing valve

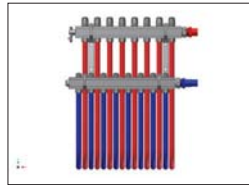

Radiant infloor manifold

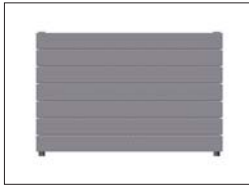

Panel radiator



Flow check valve

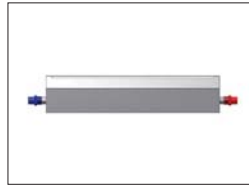

Hot water baseboard radiator



Boiler water feed with double back check valve



Air eliminator



Expansion tank



Purge assembly:
(sediment faucet and ball valve)

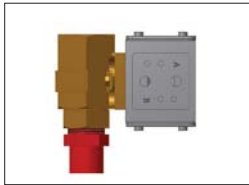

Zone valve



Hydronic air handler



Towel radiator

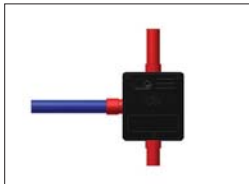

Viessmann 3-way mixing valve
with actuator motor

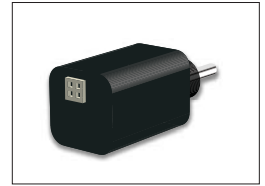

Plate and frame heat exchanger

Electrical Components



Aquastat



Secondary low water cut-off



Motorized mixing valve



Outdoor temperature sensor

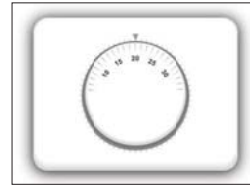

Thermostat



Temperature sensor



Viessmann Vitotrol



Multi-zone control



24V Zone valve



Circulator



120 volt power



Vitodens 200

Application #	Application Code	Page
Application 1	VD2X 1ZC1ZP.01	28
Application 2	VD2I 1ZC4ZV.01	32
Application 3	VD2I 1ZC4ZP.01	36
Application 4	VD2I 2ZC2ZP.01	40
Application 5	VD2I 3HC/ZC3ZP.01	44
Application 6	VD2I 3HC/ZC3ZP.02	48
Application 7	VD2I 3ZC9C.01	52
Application 8	2VD2I 3HC/ZC3ZP.01	56
Application 9	2VD2X 3HC3ZP.01	60
Application 10	4VD2I 2HC2ZP.01	64
Microload	Microload	68

Product Information

Vitodens 200-W B2HB 19, 26, 35, 45, 57

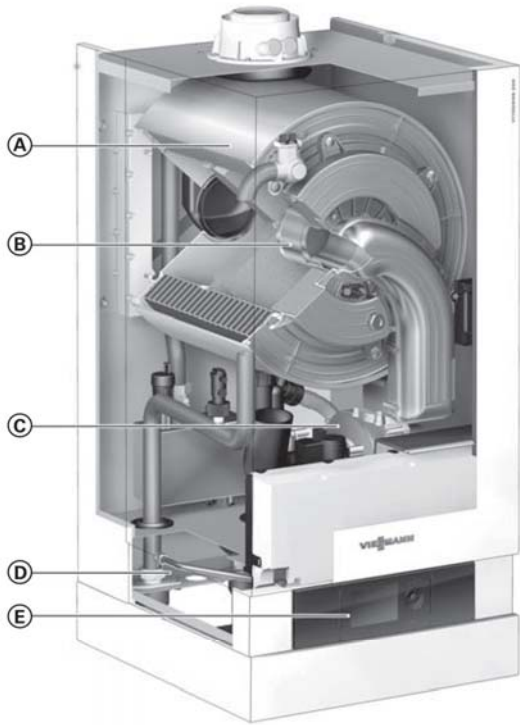

Product may not be exactly as shown

The flue gas temperature is only approximately 9-27°F (5-15°C) above boiler return temperature (see chart below).

Cross-Section

- A** Inox-Radial heat exchanger made from stainless steel – for high operational reliability and a long service life. Large heating output in the smallest of spaces
- B** Modulating MatriX cylinder burner for extremely clean combustion and quiet operation
- C** Variable speed combustion fan for quiet and economical operation
- D** Gas and water connections
- E** Digital boiler control unit

Delivered condition

Wall mounted gas condensing boiler with Inox-Radial heat exchanger, modulating MatriX cylinder burner for natural gas and LPG, plus wall mounting bracket. Vitotronic 200 for weather-compensated operation. Preset for operation with natural gas. Fully plumbed and wired. White epoxy-coated casing.

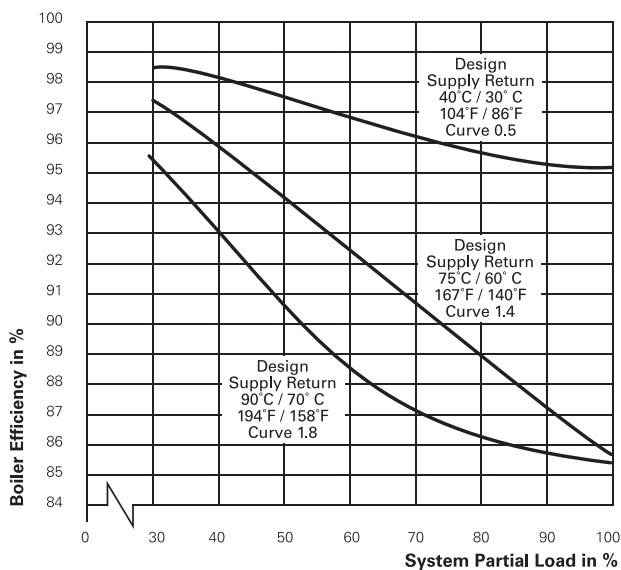

Vitodens 200-W boiler efficiency dependent on system heating water return temperatures and load conditions

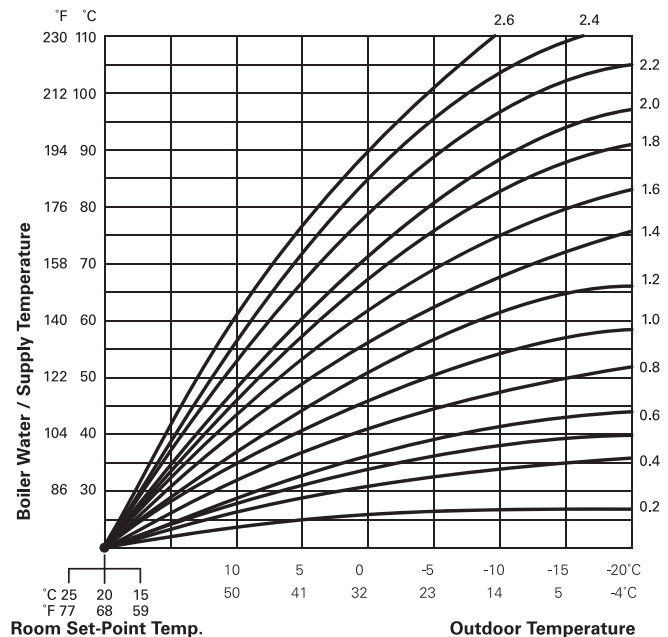

Product Information

Vitodens 200-W B2HA 88, 100, 112, 150

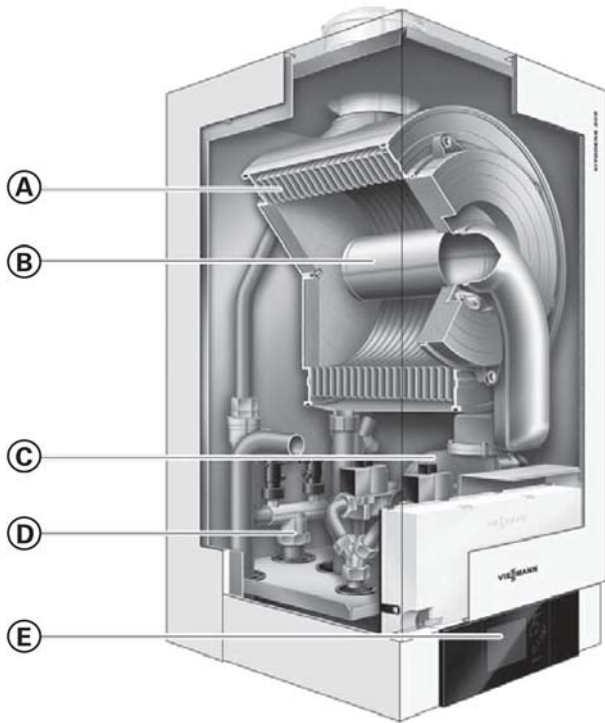

Cross-Section

- A** Innox-Radial heat exchanger made from stainless steel – for high operational reliability and a long service life. Large heating output in the smallest of spaces
- B** Modulating MatriX cylinder burner for extremely clean combustion and quiet operation
- C** Variable speed combustion fan for quiet and economical operation
- D** Gas and water connections
- E** Digital boiler control unit

Delivered condition

Wall mounted gas condensing boiler with Innox-Radial heat exchanger, modulating MatriX cylinder burner for natural gas and LPG, plus wall mounting bracket. Vitotronic 200 for weather-compensated operation. Preset for operation with natural gas. Fully plumbed and wired. White epoxy-coated casing.

Products may not be exactly as shown

The flue gas temperature is only approximately 9-27°F (5-15°C) above boiler return temperature (see chart below).

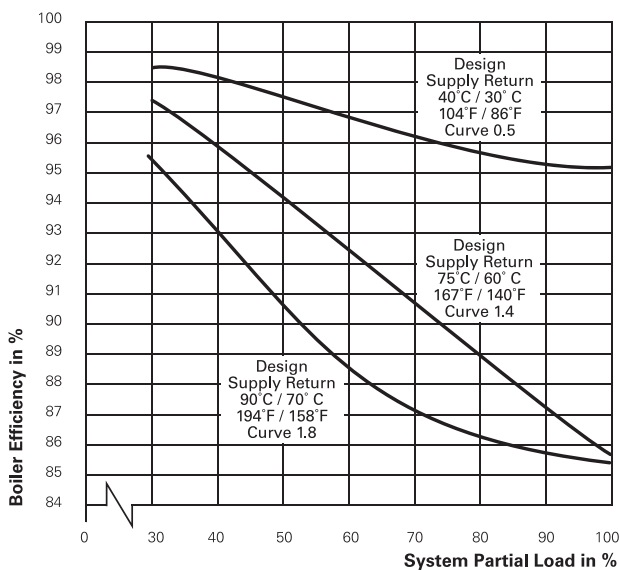

Vitodens 200-W boiler efficiency dependent on system heating water return temperatures and load conditions

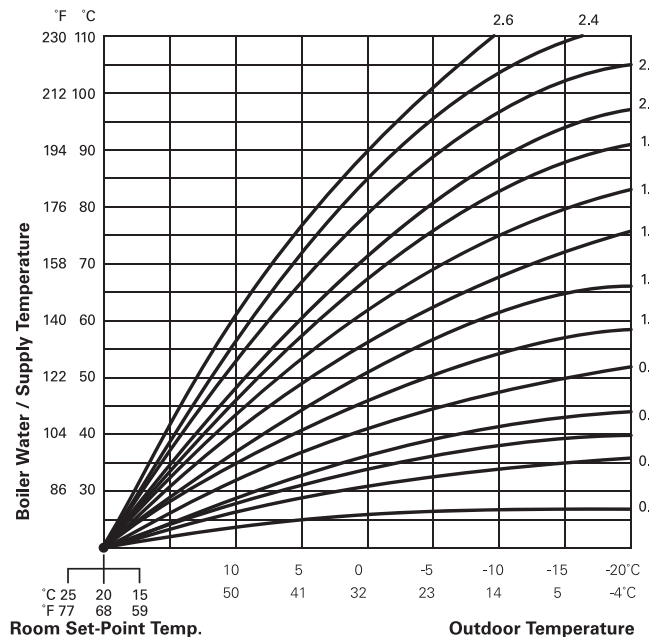

Product Information

Boiler Model No. 200-W B2HB		19, 68	26, 94	35, 125	45, 160	57, 199
CSA input Natural Gas (NG)	MBH (kW)	12-68 (3.5-20)	19-94 (5.5-27)	19-125 (5.5-37)	32-160 (9-47)	32-199 (9-58)
CSA input Liquid Propane Gas (LPG)	MBH (kW)	12-68 (3.5-20)	19-94 (5.5-27)	19-125 (5.5-37)	60-160 (17.5-47)	60-199 (17.5-58)
CSA output/DOE *1 heating capacity NG	MBH (kW)	11-64 (3.2-19)	18-88 (5-26)	18-117 (5-34)	30-149 (9-44)	30-185 (9-54)
CSA output/DOE *1 heating capacity LPG	MBH (kW)	11-64 (3.2-19)	18-88 (5-26)	18-117 (5-34)	56-149 (17-44)	56-185 (17-54)
Net AHRI rating *2	MBH (kW)	55 (16)	77 (22)	102 (30)	127 (37)	160 (47)
Heat exchanger surface area	ft. ² (m ²)	12.96 (1.2)	12.96 (1.2)	12.96 (1.2)	31.99 (2.9)	31.99 (2.9)
Min. gas supply pressure						
Natural gas	"w.c.	4	4	4	4	4
Liquid propane gas	"w.c.	10	10	10	10	10
Max. gas supply pressure *3						
Natural gas	"w.c.	14	14	14	14	14
Liquid propane gas	"w.c.	14	14	14	14	14
A.F.U.E.	%	95.0	95.0	95.0	95.0	95.0
Weight	lbs (kg)	110 (50)	110 (50)	110 (50)	210 (95)	210 (95)
Boiler water content	USG (L)	1.02 (3.88)	1.02 (3.88)	1.02 (3.88)	3.85 (14.6)	3.85 (14.6)
Boiler max. flow rate *4	GPM (L/h)	6.2 (1400)	6.2 (1400)	6.2 (1400)	14.3 (3250)	14.3 (3250)
Max. operating pressure at 210°F (99°C)	psig (bar)	45 (3)	45 (3)	45 (3)	60 (4)	60 (4)
Boiler water temperature						
- Adjustable high limit (AHL) range space heating (steady state)	°F (°C)	68 to 180 (20 to 82)	68 to 180 (20 to 82)	68 to 180 (20 to 82)	68 to 180 (20 to 82)	68 to 180 (20 to 82)
DHW production	°F (°C)	165 (74)	165 (74)	165 (74)	165 (74)	165 (74)
- Fixed high limit (FHL)	°F (°C)	210 (99)	210 (99)	210 (99)	210 (99)	210 (99)
Boiler connections						
Boiler heating supply and return	NPTM"	¾	¾	¾	1b	1b
Pressure relief valve	NPTF"	¾	¾	¾	¾	¾
Drain valve	(male thread)	¾	¾	¾	¾	¾
Boiler supply/return for indirect-fired DHW storage tank (field supplied)	NPT"	¾	¾	¾	1b	1b
Gas valve connection	NPTF"	¾	¾	¾	1	1

*1 Output based on 140°F (60°C), 120°F (49°C) system supply/return temperature.

*2 Net AHRI rating based on piping and pick-up allowance of 1.15.

*3 If the gas supply pressure exceeds the maximum gas supply pressure value, a separate gas pressure regulator must be installed upstream of the heating system.

*4 See "Waterside Flow" starting on page 8 in this manual.

Product Information

Boiler Model No. 200-W B2HB		19, 68	26, 94	35, 125	45, 160	57, 199
Dimensions						
Overall depth	inches (mm)	15.7 (400)	15.7 (400)	15.7 (400)	21 (530)	21 (530)
Overall width	inches (mm)	17 ¾ (450)	17 ¾ (450)	17 ¾ (450)	19 (480)	19 (480)
Overall height	inches (mm)	41 (1040)	41 (1040)	41 (1040)	43 ½ (1105)	43 ½ (1105)
Flue gas *5						
Temperature (at boiler return temperature of 86°F (30°C))						
- at rated full load	°F (°C)	113 (45)	113 (45)	113 (45)	95 (35)	104 (40)
- at rated partial load	°F (°C)	95 (35)	95 (35)	95 (35)	91 (33)	95 (35)
Temperature (at boiler return temperature of 140°F (60°C))						
- at rated full load	°F (°C)	154 (68)	154 (68)	154 (68)	149 (65)	158 (70)
Max. condensate flow rate *6 with natural gas and T _S /T _R = 122/86°F (50/30°C)						
	USG/h (L/h)	0.66 (2.5)	0.97 (3.7)	1.21 (4.6)	1.55 (6.0)	2.0 (8.0)
Condensate connection *7						
	hose nozzle Ø in	¾-1	¾-1	¾-1	¾-1	¾-1
Boiler flue gas connection *8						
	Ø in (mm)	2 ¾ (60)	2 ¾ (60)	2 ¾ (60)	3 ¼ (80)	3 ¼ (80)
Combustion air supply connection (coaxial)						
	outer Ø in (mm)	4 (100)	4 (100)	4 (100)	5 (125)	5 (125)
Sound Rating						
- at maximum input	dB	41	48	51	56	67
- at minimum input	dB	35	36	36	39	39

*5 Measured flue gas temperature with a combustion air temperature of 68°F (20°C).

*6 Based on maximum input rate.

*7 Requires 1 inch (25 mm) tubing. See the Installation Instructions of the Vitodens 200-W, B2HB for details.

*8 For side wall vent installations (coaxial system):

Do not exceed max. equivalent length specified in the Installation Instructions of the Vitodens 200-W, B2HB Venting System.

Do not attempt to common-vent Vitodens 200-W B2HB 19, 26, 35 with any other appliance.

The Vitodens 200-W B2HB 45, 57 can only be common vented with other Vitodens 200-W boilers of the same size and series.

Side wall co-axial vent installation must include Viessmann protective screen!

For details refer to the Installation Instructions for the Vitodens 200-W, B2HB Venting System.

For information regarding other Viessmann System Technology componentry, please reference documentation of respective product.

Note:

For high altitude installation at 10,000 ft. the input for model B2HB 19 to 57 will have an altitude deration of 21%.

Product Information

Boiler Model No. B2HA		88 *A	100 *A	112 *B	150 *A
CSA input Natural Gas (NG)	MBH	71-311	71-352	113-399	113-530
	(kW)	(21-91)	(21-103)	(33-117)	(33-155)
CSA input Liquid Propane Gas (LPG)	MBH	104-311	104-352	113-399	113-530
	(kW)	(30-91)	(30-103)	(33-117)	(33-155)
CSA output NG *3	MBH	67-294	67-333	103-375	103-495
	(kW)	(20-86)	(20-98)	(30-110)	(30-145)
CSA output LPG *3	MBH	98-294	98-333	103-375	103-495
	(kW)	(29-86)	(29-98)	(30-110)	(30-145)
DOE/AHRI Gross output	MBH	292	329	371	490
	(kW)	(85)	(96)	(109)	(144)
Net AHRI Rating *C	MBH	254	286	323	426
	(kW)	(74)	(84)	(95)	(125)
Heat exchanger surface area	ft. ²	28.88	28.88	36.78	36.78
	(m ²)	(2.68)	(2.68)	(3.41)	(3.41)
Min. gas supply pressure					
Natural gas	"w.c.	4	4	4	4
Liquid propane gas	"w.c.	10	10	10	10
Max. gas supply pressure *7					
Natural gas	"w.c.	14	14	14	14
Liquid propane gas	"w.c.	14	14	14	14
CSA thermal/combustion efficiency					
ANSI Z21,13/CSA 4.9	%	94.5	94.5	93.9	93.5
Weight	lbs	194	194	298	298
	(kg)	(88)	(88)	(135)	(135)
Boiler water content	USG	3.4	3.4	4	4
	(L)	(12.8)	(12.8)	(15)	(15)
Boiler max. flow rate *2	GPM	25	25	37.9	38
	(L/h)	(5700)	(5700)	(8600)	(8600)
Max. operating pressure at 210°F (99°C)	psig	60	60	80	80
	(bar)	(4)	(4)	(5.5)	(5.5)
Boiler water temperature					
- Adjustable high limit (AHL) range space heating (steady state)		°F	68 to 185	68 to 185	68 to 185
	(°C)	(20 to 85)	(20 to 85)	(20 to 85)	(20 to 85)
DHW production		°F	176	176	180
	(°C)	(80)	(80)	(82)	(82)
- Fixed high limit (FHL)		°F	210	210	210
	(°C)	(99)	(99)	(99)	(99)
Boiler connections					
Boiler heating supply and return	NPTM"	1 ½	1 ½	2	2
Pressure relief valve	NPTF"	¾	¾	¾	¾
Drain valve	(male thread)	¾	¾	¾	¾
Boiler supply/return for indirect-fired DHW storage tank (field supplied)	NPT"	1 ½	1 ½	2	2
Gas valve connection	NPTF"	1	1	1	1

*A For high altitude installations 5,000 - 10,000 ft. (1500 m - 3000 m), the input for model B2HA 88,100 and 150 will have an altitude de-ration of 14% for 5,000 ft. (1500 m) and 29% for 10,000 ft. (3000 m) average of 2.8% / 1,000 ft. (305 m).

*B The input for model B2HA 112 at 10,000 ft. (3000 m) will have an input de-rate of 13%.

*C Net AHRI rating based on piping and pick-up allowance of 1.15.

*7 If the gas supply pressure exceeds the maximum gas supply pressure value, a separate gas pressure regulator must be installed upstream of the heating system.

*2 See "Waterside Flow" starting on page 10 of this manual.

*3 Output based on 180°F (82°C), 80°F (26°C) system supply/return temperature.

Product Information

Boiler Model No. B2HA		88 *A	100 * A	112 * B	150 * A
Dimensions					
Overall depth	inches (mm)	21 (530)	21 (530)	27.1 (698)	27.1 (698)
Overall width	inches (mm)	19 (480)	19 (480)	23 ⁵ / ₈ (600)	23 ⁵ / ₈ (600)
Overall height *8	inches (mm)	43 ¹ / ₂ (1105)	43 ¹ / ₂ (1105)	44 ¹ / ₂ (1128)	44 ¹ / ₂ (1128)
Flue gas *4					
Temperature (at boiler return temperature of 86°F (30°C))					
- at rated full load	°F (°C)	135 (57)	135 (57)	124 (51)	140 (60)
- at rated partial load	°F (°C)	99 (37)	99 (37)	102 (39)	102 (39)
Temperature (at boiler return temperature of 140°F (60°C))	°F (°C)	162 (72)	162 (72)	158 (70)	165 (74)
Max. condensate flow rate *5 for NG and LPG T _S /T _R = 104/86°F (40/30°C)					
	USG/h (L/h)	3.1 (11.7)	3.5 (13.1)	4.35 (16.5)	5.28 (20.0)
Condensate connection *6					
	hose nozzle Ø in.	¾- 1	¾- 1	¾- 1	¾- 1
Boiler flue gas connection *7					
	Ø in. (mm)	4 ³ / ₈ (110)	4 ³ / ₈ (110)	4 ³ / ₈ (110)	4 ³ / ₈ (110)
Combustion air supply connection (coaxial)					
	outer Ø in. (mm)	6 (150)	6 (150)	6 (150)	6 (150)
Sound Rating					
- at maximum input	dB	69	69	57	61
- at minimum input	dB	38	38	40	40

*A For high altitude installations 5,000 - 10,000 ft. (1500 m - 3000 m), the input for model B2HA 88,100 and 150 will have an altitude de-ration of 14% for 5,000 ft. (1500 m) and 29% for 10,000 ft. (3000 m) average of 2.8% / 1,000 ft. (305 m).

*B The input for model B2HA 112 at 10,000 ft. (3000 m) will have an input de-rate of 13%.

*4 Measured flue gas temperature with a combustion air temperature of 68°F (20°C).

*5 Based on maximum input rate.

*6 Requires 1 inch (25 mm) tubing. See the Installation Instructions of the Vitodens 200-W, B2HA for details.

*7 For side wall vent installations (coaxial system):

Do not exceed max. equivalent length specified in the Installation Instructions of the Vitodens 200-W, B2HA Venting System.

Side wall co-axial vent installation must include Viessmann protective screen!

For details refer to the Installation Instructions for the Vitodens 200-W, B2HA Venting System.

The Vitodens 200-W can only be common vented with other Vitodens 200-W boilers of the same size and series.

For details refer to the Common Venting Manual.

*8 Add approximately 2½ inches (65 mm) for coaxial vent pipe transition adaptor.

For information regarding other Viessmann System Technology componentry, please reference the documentation of each respective product.

Boiler Dimensions - Models 200-W, B2HB 19, 26, 35

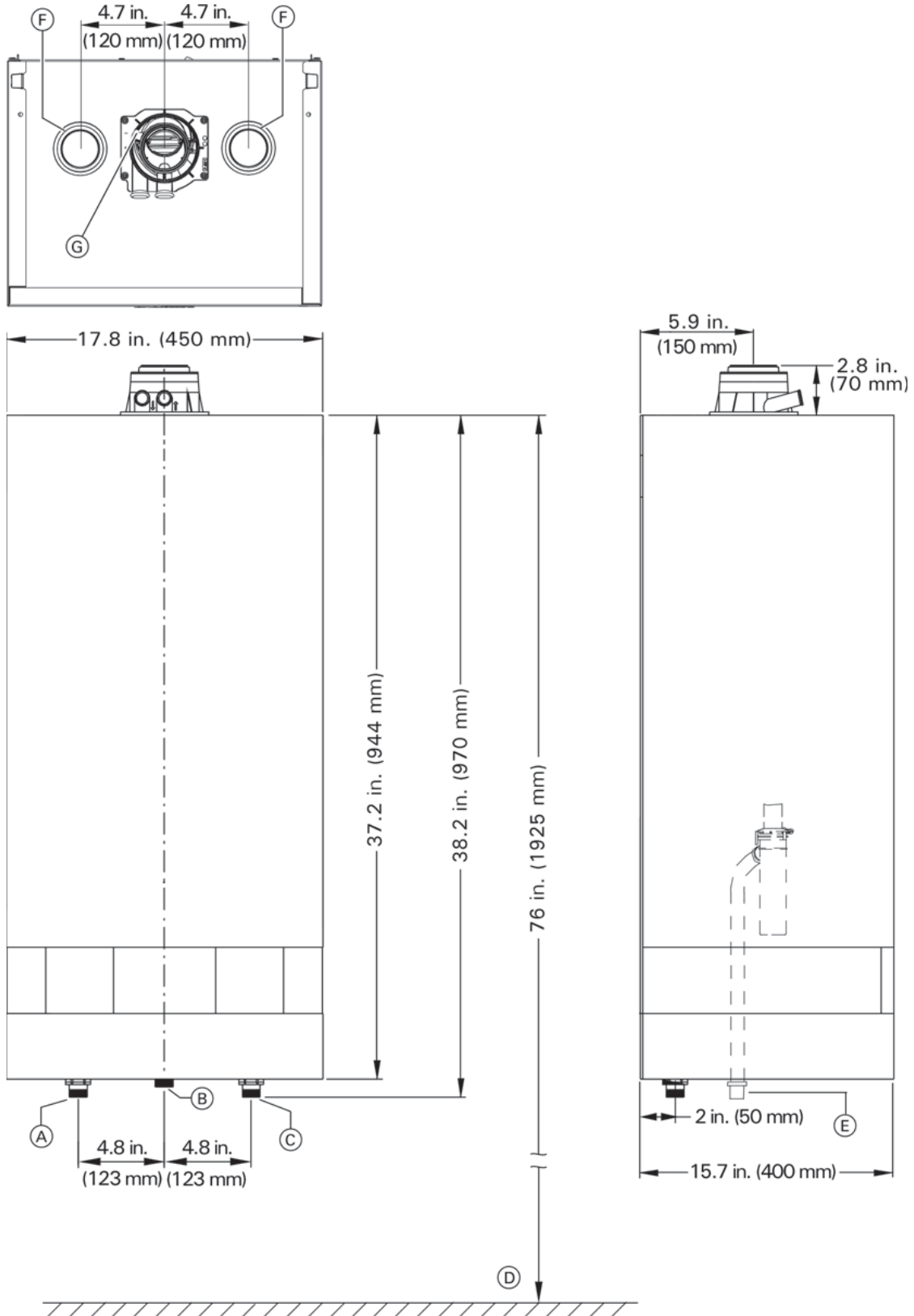

Boiler Dimensions - Models 200-W, B2HB 45, 57

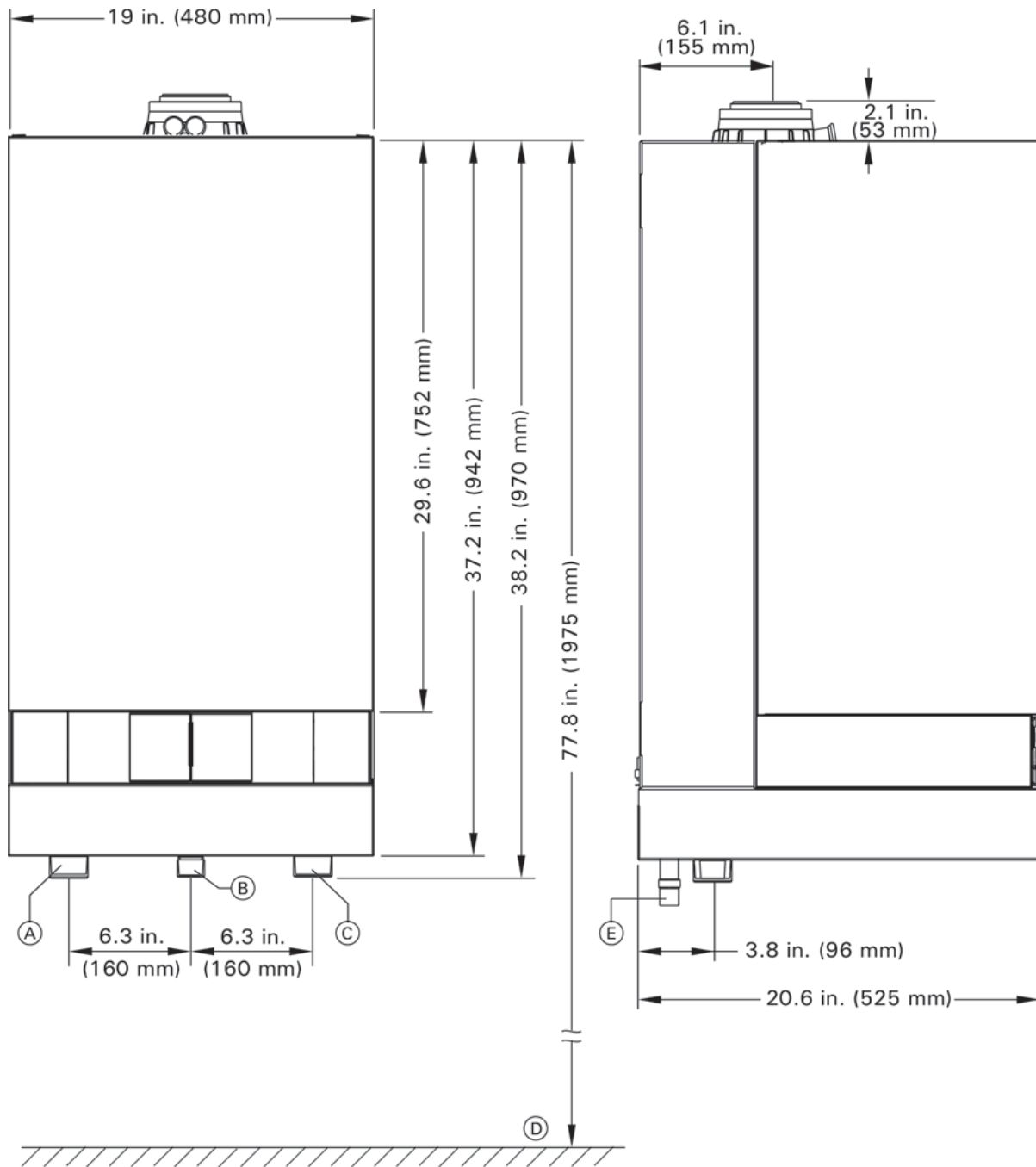

Legend

- A Boiler supply, 1 1/2"
- B Gas connection, 1" NPTF
- C Boiler return, 1 1/2"
- D Recommended height (single boiler system)
- E Condensate drain

Boiler Dimensions - Model B2HA 88, 100

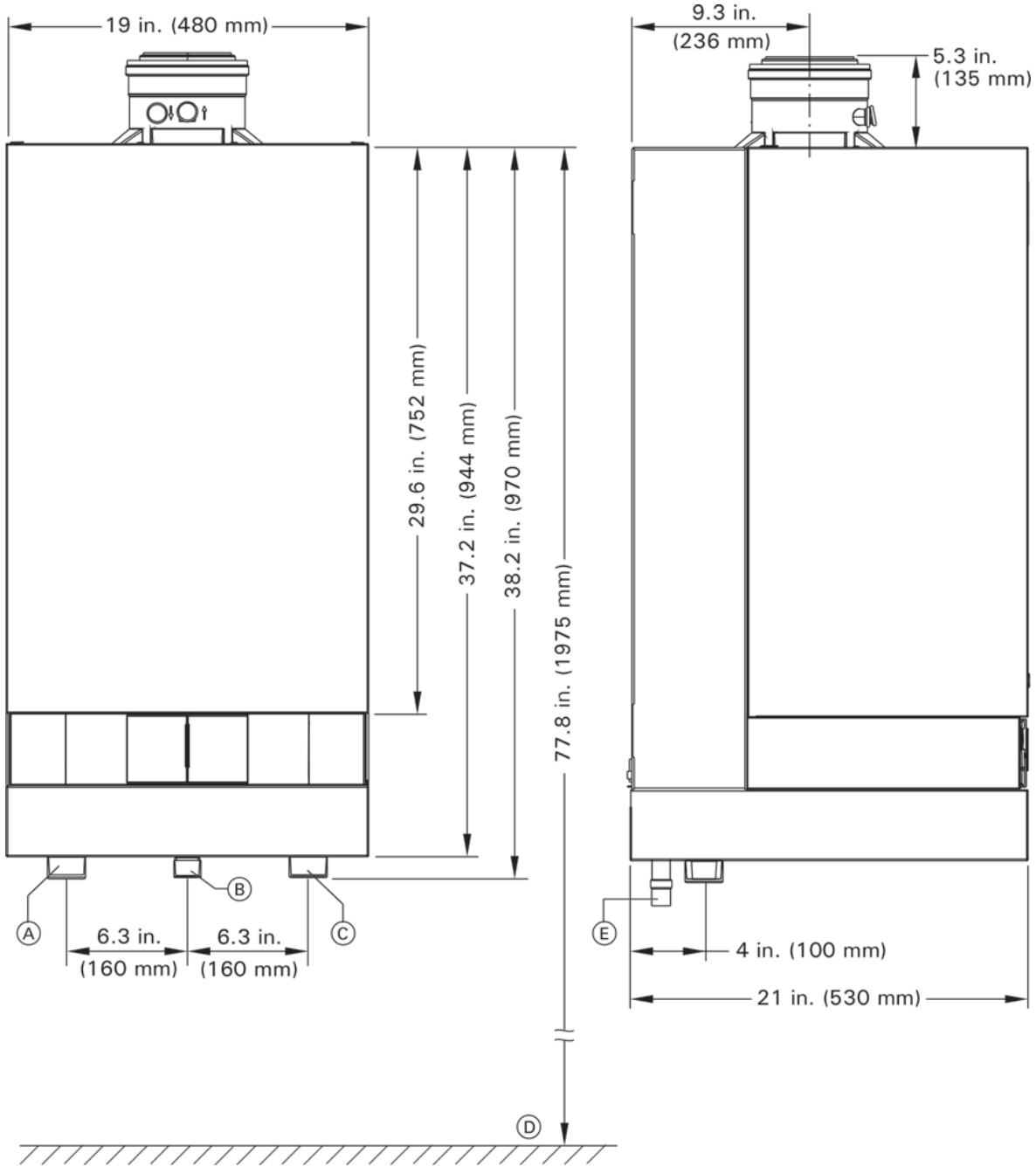

Legend

- A Boiler supply
- B Gas connection, 1" NPTF
- C Boiler return
- D Recommended height (single boiler system)
- E Condensate drain

Boiler Dimensions - Models B2HA 112, 150

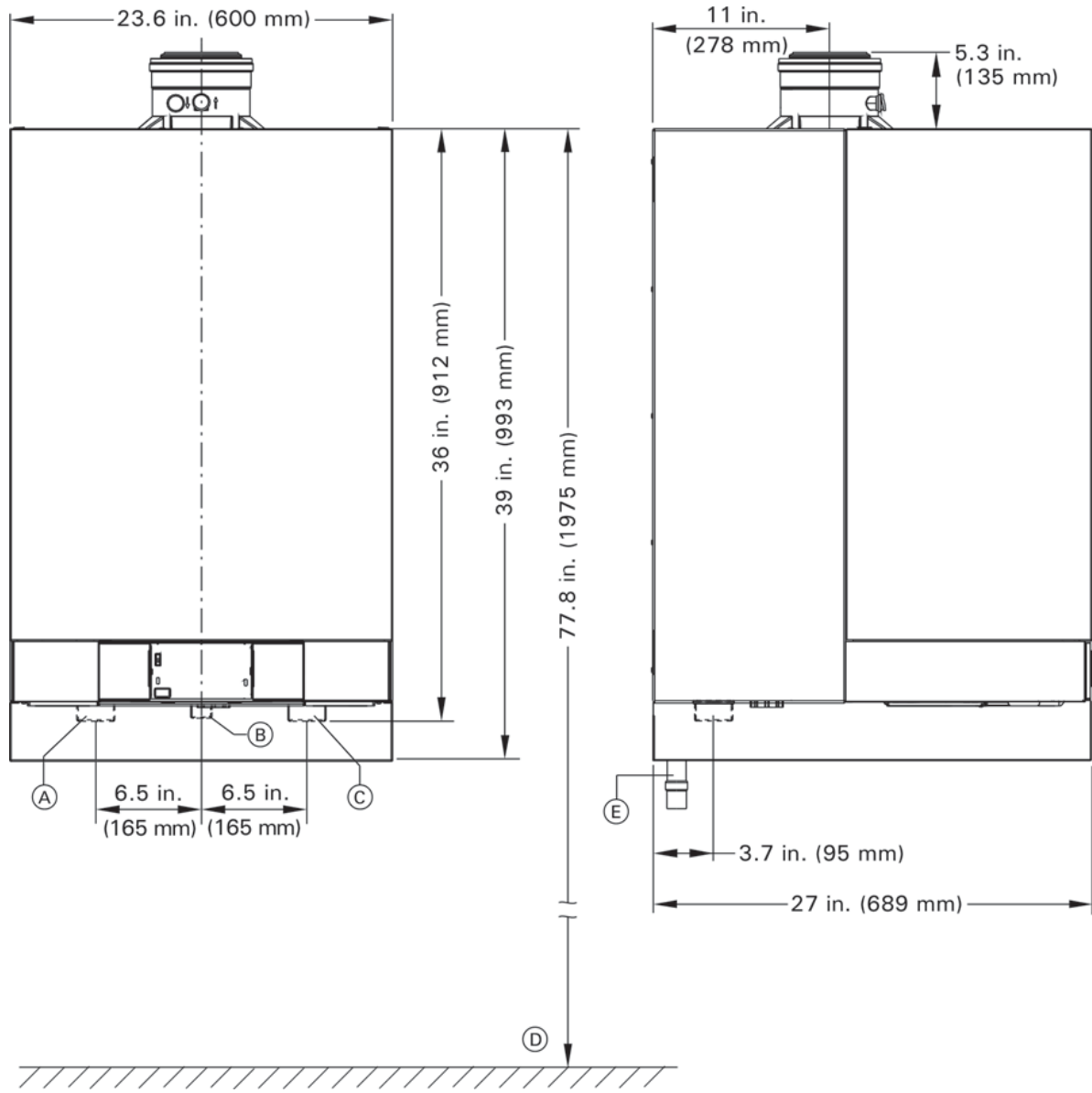

Legend

- A Boiler supply
- B Gas connection, 1" NPTF
- C Boiler return
- D Recommended height (single boiler system)
- E Condensate drain

Service Clearances

Recommended minimum service clearances

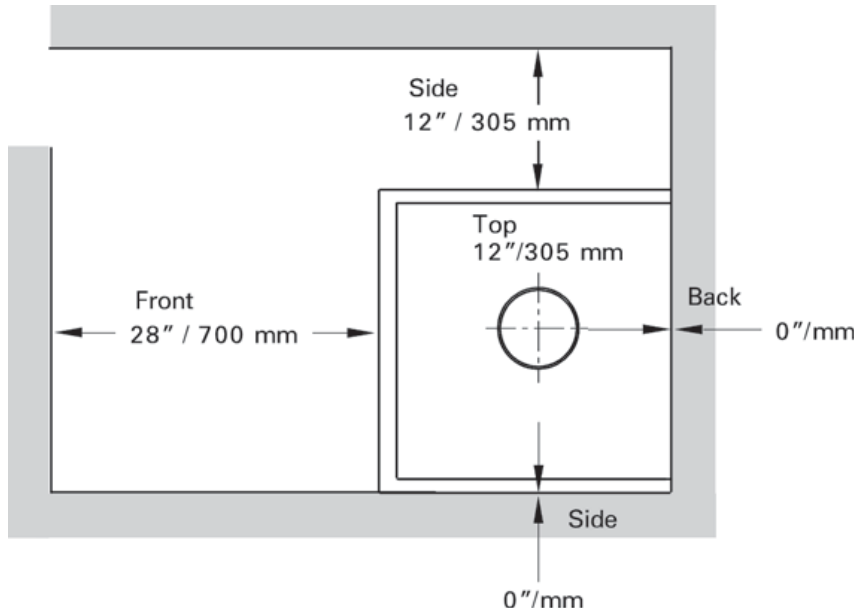

Minimum clearances to combustibles

Top	Front	Rear	Left	Right	Vent pipe *1
0	0 AL, CL	0	0	0	0

AL= Alcove

CL= Closet

* 1 Refer to the Installation Instructions of the Vitodens 200-W, B2HB Venting System for details.

Note:The Vitodens boiler has passed the zero inches vent clearance to combustibles testing requirements dictated by the Harmonized Standard ANSI Z21.13. CSA 4.9 (latest edition) and therefore is listed for zero clearance to combustibles when vented with a single wall special venting system (AL-29-4C material). The zero inches vent clearance to combustibles for the Vitodens boiler supercedes the clearance to combustibles listing that appears on the special venting system label.

Waterside Flow

Waterside Flow (primary circuit)

The Vitodens 200-W, B2HB is designed for closed loop, forced circulation hot water heating systems only. Use standard friction loss method for pipe sizing. Observe boiler maximum and minimum flow rate limitations. If system flow rate exceeds boiler maximum flow rate (as stated above), falls below the minimum flow rate or if system flow rate is unknown, Viessmann strongly recommends the installation of a low-loss header. An alternative method may be used, such as primary secondary piping using closely spaced tees.

A low-loss header offers additional benefits not provided by a pair of closely spaced tees. Viessmann therefore strongly recommends and prefers the use of a low-loss header over closely spaced tees. See pages 25 and 26 for low-loss header information. Once the low-loss header is connected, the built-in low-loss header logic of the Vitodens 200-W boiler ensures the required Δt across the system through the sensory communication between the low-loss header and the boiler.

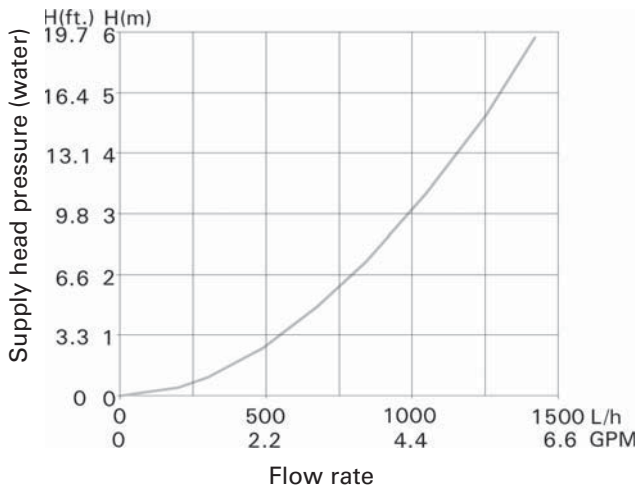

Pressure drop (primary circuit) for Vitodens 200-W, B2HB 19, 26, 35
For sizing an on-site circulation system.
Max. flow rate: 6.2 GPM (1400 L/h)

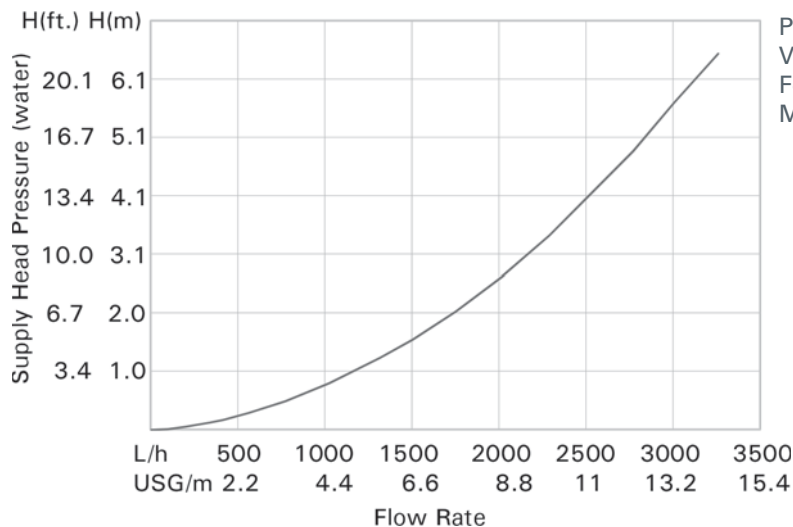

Pressure drop (primary circuit) for Vitodens 200-W, B2HB 45 - 57
For sizing an on-site circulation system.
Max. flow rate: 14.3 GPM (3250 L/H)

Waterside Flow (primary circuit)

The Vitodens 200-W, B2HA is designed for closed loop, forced circulation hot water heating systems only. Use standard friction loss method for pipe sizing. Observe boiler maximum and minimum flow rate limitations. If system flow rate exceeds boiler maximum flow rate (as stated below), falls below the minimum flow rate or if system flow rate is unknown, Viessmann strongly recommends the installation of a low-loss header. An alternative method may be used, such as primary secondary piping using closely spaced tees.

A low-loss header offers additional benefits not provided by a pair of closely spaced tees. Viessmann therefore strongly recommends and prefers the use of a low-loss header over closely spaced tees. Once the low-loss header is connected, the built-in low-loss header logic of the Vitodens 200-W boiler ensures the required Δt across the system through the sensory communication between the low-loss header and the boiler.

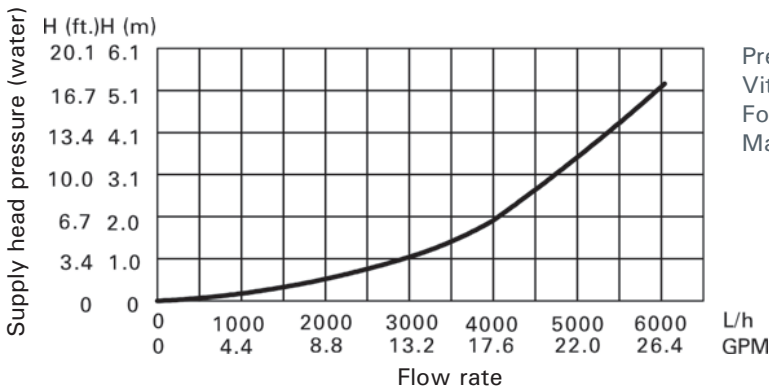

Pressure drop (primary circuit) for Vitodens 200-W, B2HA 88, 100
For sizing an on-site circulation system.
Max. flow rate: 25 USGPM (5700 L/h)

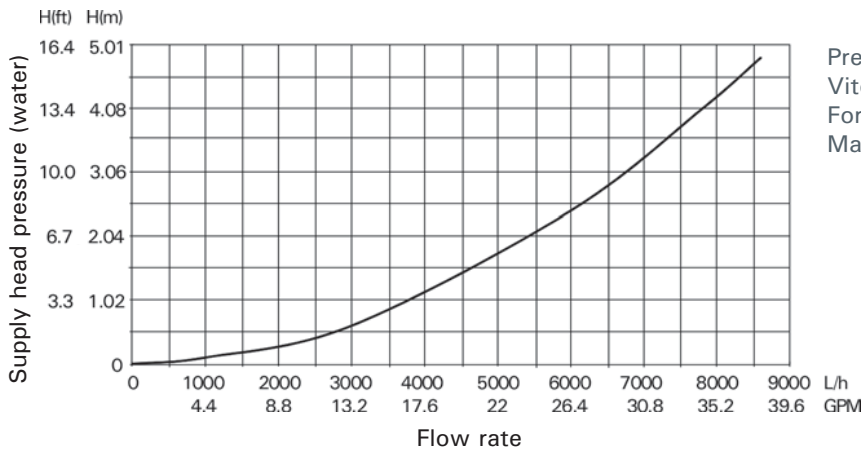

Pressure drop (primary circuit) for Vitodens 200-W, B2HA 112, 150
For sizing an on-site circulation system.
Max. flow rate: 38 USGPM (8600 L/h)

Pump Information

Heating Circuit / Boiler Pumps

Viessmann offers a variety of Grundfos heating circuit/boiler pumps which meet typical Vitodens system installation requirements (see “Heating circuit pump (field supplied)” or “Boiler pump (field supplied)” in the Installation Examples starting on page 28). See tables below for recommended pumps. Refer to the graph on page 8 for the proper waterside boiler friction loss calculations. The following pumps have been selected based on boiler heat exchanger head loss and boiler piping to a low-loss header.

Before using the following pumps for a DHW tank application, find out the proper pressure drop through the tank, the required temperature difference through the coil and system piping head loss of the domestic hot water.

IMPORTANT

Pump selection must be based on accurate system flow and pressure drop calculations (includes DHW sizing).

Model		B2HB 19	B2HB 26	B2HB 35
Flow rate				
20°F Δt	GPM (L/h)	6.4 (1453)	--	--
25°F Δt	GPM (L/h)	5.1 (1163)	--	--
30°F Δt	GPM (L/h)	4.3 (969)	5.9 (1332)	--
35°F Δt	GPM (L/h)	3.7 (830)	5.0 (1142)	--
40°F Δt	GPM (L/h)	3.2 (727)	4.4 (999)	5.9 (1328)
Flow limitation	GPM (L/h)	6.2 (1400)	6.2 (1400)	6.2 (1400)
Recommended boiler pumps		Grundfos UPS 15-58 (3-speed), Taco 0015, Wilo Star S 21 FX		

Pump Selection

Model B2HB 45	Flow rate GPM (L/h)	Boiler pressure drop ft. (m)	Recommended pump option 1 Grundfos	Recommended pump option 2 Grundfos
20° F Δt	--	--	--	--
25° F Δt	11.9 (2707)	15.4 (4.7)	UPS 26-99FC, 115V, Speed2	UP 26-64F, 115V
30° F Δt	9.9 (2256)	10.4 (3.2)	UPS 26-99FC, 115V, Speed2	--
35° F Δt	8.5 (1934)	8.0 (2.5)	UPS 26-99FC, 115V, Speed1	--
40° F Δt	7.5 (1692)	6.3 (1.9)	UPS 26-99FC, 115V, Speed1	--
Flow limitation	14.3 GPM (3250 L/h)			

Model B2HB 57	Flow rate GPM (L/h)	Boiler pressure drop ft. (m)	Recommended pump option 1 Grundfos	Recommended pump option 2 Grundfos
20° F Δt	--	--	--	--
25° F Δt	--	--	--	--
30° F Δt	12.3 (2801)	13.5 (4.1)	UPS 26-99FC, 115V, Speed2	UP 26-64F, 115V
35° F Δt	10.6 (2401)	12.7 (3.9)	UPS 26-99FC, 115V, Speed2	UP 26-64F, 115V
40° F Δt	9.3 (2101)	9.0 (2.7)	UPS 26-99FC, 115V, Speed1	--
Flow limitation	14.3 GPM (3250 L/h)			

Pump Information

Heating Circuit / Boiler Pumps

Viessmann offers a variety of Grundfos heating circuit / boiler pumps which meet typical Vitodens system installation requirements (see "Heating circuit pump (field supplied)" or "Boiler pump (field supplied)" in the Installation Examples starting on page 31). See tables below for recommended pumps. Refer to the graphs on page 9 for the proper waterside boiler friction loss calculations. The following pumps have been selected based on boiler heat exchanger head loss and boiler piping to a low-loss header.

Before using the following pumps for a DHW tank application, find out the proper pressure drop through the tank, the required temperature difference through the coil and system piping head loss of the domestic hot water.

IMPORTANT

Pump selection must be based on accurate system flow and pressure drop calculations (incl. DHW sizing).

Model B2HA 88	Flow rate	Boiler pressure drop (ft.)	Recommended pump Grundfos
20°F Δt	--	--	--
25°F Δt	23.5	11.2	UPS 26-99FC, 115V, Speed 3
30°F Δt	19.6	9.5	UPS 26-99FC, 115V, Speed 3
35°F Δt	16.8	5.5	UPS 26-99FC, 115V, Speed 2
40°F Δt	14.7	4.5	UPS 26-99FC, 115V, Speed 2
Flow limitation GPM (L/h)	5700 (25)		

Model B2HA 100	Flow rate	Boiler pressure drop (ft.)	Recommended pump Grundfos
20°F Δt	--	--	--
25°F Δt	--	--	--
30°F Δt	22.2	12.0	UPS 32-160/2, 115V, Speed 1 / UPS 26-99FC, 115V, Speed 3
35°F Δt	19.0	8.5	UPS 26-99FC, 115V, Speed 3
40°F Δt	16.7	6.0	UPS 26-99FC, 115V, Speed 2
Flow limitation GPM (L/h)	5700 (25)		

Model B2HA 112	Flow rate	Boiler pressure drop (ft.)	Recommended pump Grundfos
20°F Δt	37.5	15.0	UPS 32-160/2, 115V, Speed 1 / UPS 26-150F, 115V, Speed 2
25°F Δt	30.0	11.3	UPS 32-160/2, 115V, Speed 1 / UPS 26-150F, 115V, Speed 2
30°F Δt	25.0	8.8	UPS 32-160/2, 115V, Speed 1 / UPS 26-150F, 115V, Speed 2
35°F Δt	21.4	6.5	UPS 32-160/2, 115V, Speed 1 / UPS 26-99FC, 115V, Speed 3
40°F Δt	19.5	4.8	UPS 26-99FC, 115V, Speed 2 / UPS 26-150F, 115V, Speed 1
Flow limitation GPM (L/h)	8600 (37.9)		

Model B2HA 150	Flow rate	Boiler pressure drop (ft.)	Recommended pump Grundfos
20°F Δt	--	--	--
25°F Δt	--	--	--
30°F Δt	33.0	12.6	UPS 32-160/2, 115V, Speed 1 / UPS 26-150F, 115V, Speed 3
35°F Δt	28.3	9.4	UPS 32-160/2, 115V, Speed 1 / UPS 26-150F, 115V, Speed 2
40°F Δt	24.8	8.0	UPS 26-99FC, 115V, Speed 3 / UPS 32-160/2, 115V, Speed 1 /
Flow limitation GPM (L/h)	8600 (37.9)		

System Design Considerations

Boiler location

As a direct vent appliance, the Vitodens 200-W can be installed for room air independent operation (sealed combustion) regardless of size and ventilation method of the room in which it is located.

The Vitodens 200-W can be installed, for example, in the main living area of a house, in non-ventilated utility rooms, cupboards, closets and alcoves with no clearance required from combustible materials, as well as in attics with a direct outlet for the flue gas/fresh air system. Follow all local and national codes.

Flue gas system

PPS (Polypropylene) concentric flue gas/fresh air systems for room air independent operation (sealed combustion) and side wall venting are tested to ANSI Z21.13 - CSA 4.9 - 2000 standards and are certified together with the Vitodens 200-W boiler as a constructional unit.

The Vitodens 200-W boiler may also be vented vertically, using an AL29-4C® special stainless steel, single-wall, room air dependent venting system (UL listed for category IV). For a more detailed description of the direct vent and single-wall vent system, please refer to the Vitodens 200-W Venting System Installation Instructions.

Flue gas temperature protection

Flue pipes used for the Vitodens 200-W are suitable for max. flue gas temperatures of up to 230°F (110°C). No flue gas temperature protection is required as the maximum permissible flue gas temperature is not exceeded in any operating condition or in the event of malfunctioning.

Low water cut-off

A low water cut-off may be required by local codes. If the boiler is installed above the radiation level, a low water cut-off device of approved type must be installed in all instances. An approved type low water cut-off device must be provided by the heating contractor. Do not install an isolation valve between the boiler and the low water cut-off.

Water connections

Vitodens 200-W boilers can be used in any fully pumped hot water heating system.

Minimum system pressure is 1 bar (14 psig).

Chemical corrosion protection products
Corrosion does not typically occur in sealed heating systems which have been correctly installed and are correctly operated.

Many manufacturers of plastic pipes recommend the use of chemical additives. In this case, only those commercially available corrosion protection products approved for boilers with domestic hot water heating via single-wall heat exchangers (instantaneous plate heat exchangers or DHW tanks) must be used.

Water quality

Treatment for boiler feed water should be considered in areas of known problems, such as where a high mineral content and hardness exist. In areas where freezing might occur, an antifreeze may be added to the system water to protect the system. Please adhere to the specifications given by the antifreeze manufacturer. Do not use automotive silicate based antifreeze.

Please observe that an antifreeze/water mixture may require a backflow preventer within the automatic water feed and influence components such as diaphragm expansion tanks, radiation, etc. Maximum antifreeze content is 50% for the Vitodens 200-W boiler. Do not use antifreeze other than specifically made for hot water heating systems. System also may contain components which might be negatively affected by antifreeze. Check total system frequently when filled with antifreeze. Advise system operator/ultimate owner that system is filled with a glycol mix. The heating contractor must provide a MSDS (Material Safety Data Sheet) for the antifreeze used to the system operator/ultimate owner.

Total permissible hardness of the fill and top-up water

Total heating output	Specific heating volume					
	< 5 USG per 3412 BTU		≥ 5USG per 3412 BTU to <13USG per 3412 BTU		≥ 13USG per 3412 BTU	
MBH						
≤ 170	300 ppm	17.5 gpg	200 ppm	11.7 gpg	2 ppm	0.11 gpg
> 170 to ≤ 682	200 ppm	11.7 gpg	150 ppm	8.8 gpg	2 ppm	0.11 gpg
> 682 to ≤ 170	150 ppm	8.8 gpg	2 ppm	0.11 gpg	2 ppm	0.11 gpg
> 2050	2 ppm	0.11 gpg	2 ppm	0.11 gpg	2 ppm	0.11 gpg

ppm - parts per million

gpg - grains per gallon

Considerations

System layout

- The max. boiler water temperature for space heating and DHW production is 165°F (74°C) for models B2HB 19 to 35. To minimize distribution losses, Viessmann recommends that the heating and domestic hot water systems be based on a maximum boiler supply temperature of 158°F (70°C).
- Due to the low return temperatures required for gas condensing, no mixing valves should be used in the heating circuit whenever possible. If mixing valves are required, e.g. for multi-circuit systems or underfloor heating systems, only 3-way mixing valves must be used.
Do not use 4-way mixing valves with condensing boilers.

Underfloor heating systems

For underfloor heating systems Viessmann recommends the use of plastic tubing with an oxygen diffusion barrier in order to prevent the diffusion of oxygen through tubing. If plastic tubing without an oxygen diffusion barrier is used in underfloor heating systems, Viessmann recommends that such systems be separated from the boiler with a heat exchanger.

Underfloor heating systems and heating circuits containing a very large volume of water must be connected to the boiler via a 3-way mixing valve; please refer to the applicable installation example in this manual.

Oxygen diffusion barrier underfloor tubing

The boiler warranty does not cover leaks resulting from corrosion caused by the use of underfloor plastic tubing without an oxygen diffusion barrier. Such systems must have the non-oxygen diffusion barrier tubing separated from the boiler with a heat exchanger. Viessmann recommends the use of underfloor plastic tubing with an oxygen diffusion barrier.

Warranty

Our warranty does not cover damages resulting from the following:

- installation or service by unqualified and unlicensed personnel.
- attempting to perform any repair work on the boiler other than that mentioned in the boiler literature.
- tampering with or attempting, without Viessmann permission, to readjust the factory settings of the;
 - combination gas valve
 - combustion air opening of the burner blower
- leaks resulting from corrosion caused by the use of underfloor plastic tubing without an oxygen diffusion barrier. For detailed warranty information, please read warranty sheet supplied with product.

Product Information

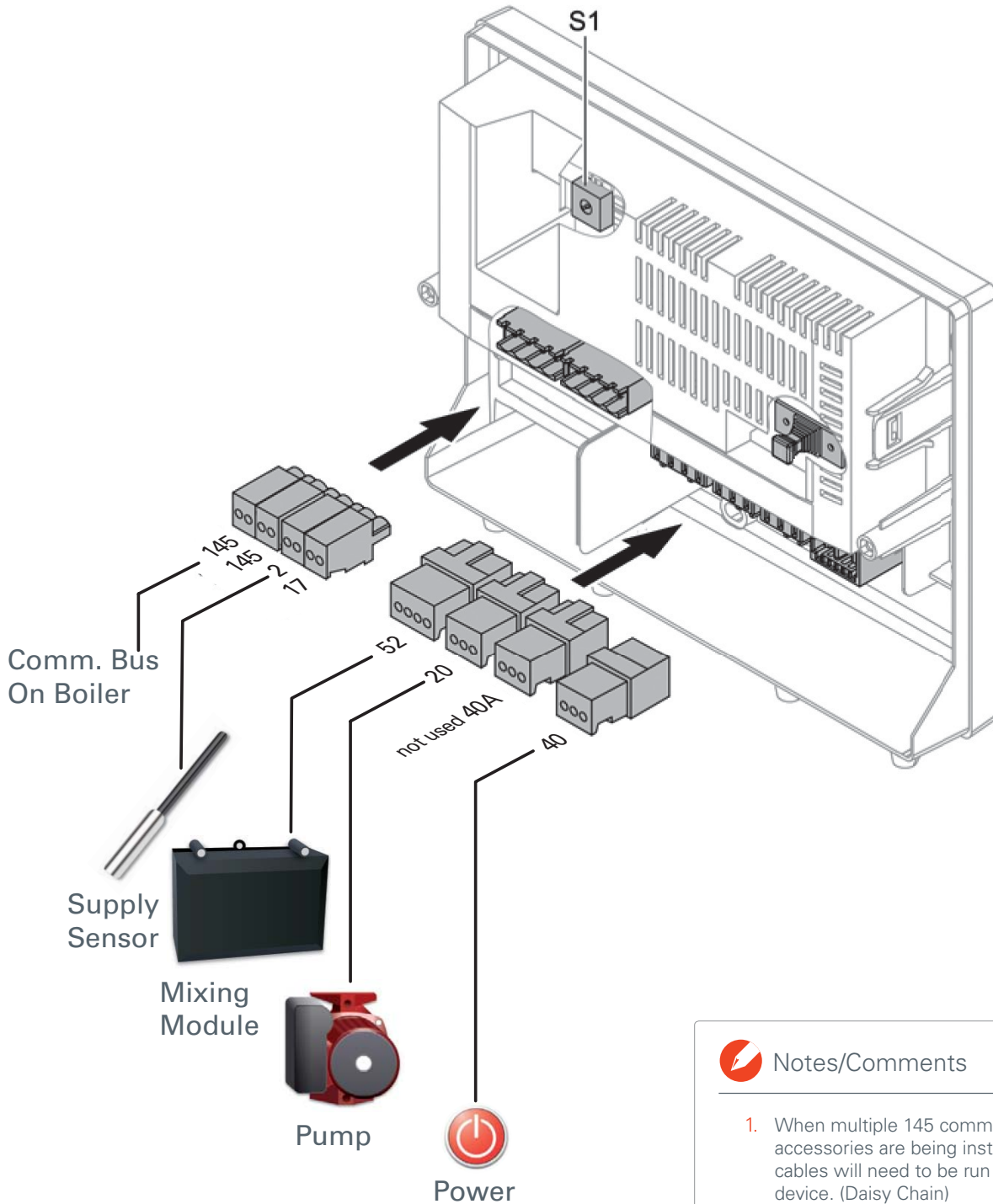

Notes/Comments

1. When multiple 145 communication accessories are being installed, 145 cables will need to be run from device to device. (Daisy Chain)
2. Ensure to set the S1 switch to assign the mixing valve heating circuit.

Zone Control Wizard Setup



Notes/Comments

1. Power Boiler ON
2. Setting of Time and Date
3. Press Menu+OK buttons to access Service Menu
4. Down Arrow to Service Functions
5. Press OK
6. Activate Yes/No
7. Arrow up to YES
8. Press OK

System with 1 Zone Circuit

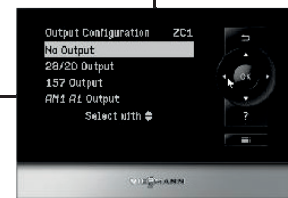
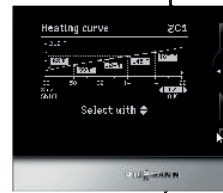
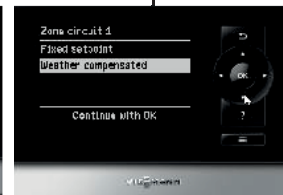
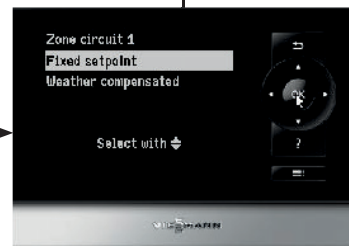
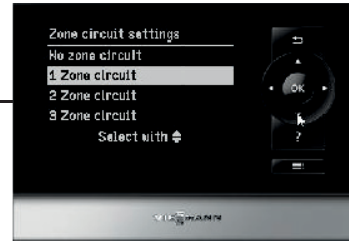

Select number of ZC circuits 1, 2 or 3
ZC2 and ZC3 Configuration Setup

Press OK at each screen to enter setting and move to next step

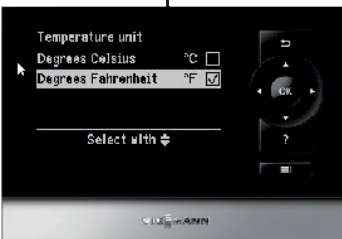

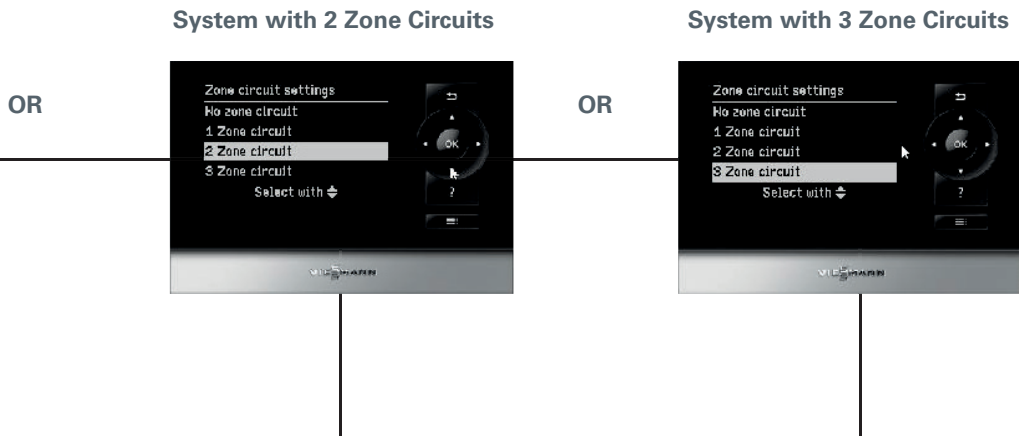

Operational Screen Information

ZC Fixed Setpoint Configured



ZC Weather Compensated Configured



User Interface Details:

1. Indication of ZC circuit boiler is configured for ZC1/ZC2/ZC3 use arrows left or right to select.
2. Display will show III when a ZC call is present and a symbol if ZC1/ZC2/ZC3 are configured with an associated pump output.
3. Display of actual boiler water temperature.
4. Flame indication when burner ON and will show % of modulation.
5. Target temperature of zone. The Fixed Setpoint will show the set temperature during configuration and Weather Compensated will show target based on slope and shift.
6. Outdoor temperature is shown when Weather Compensated ZC is configured.



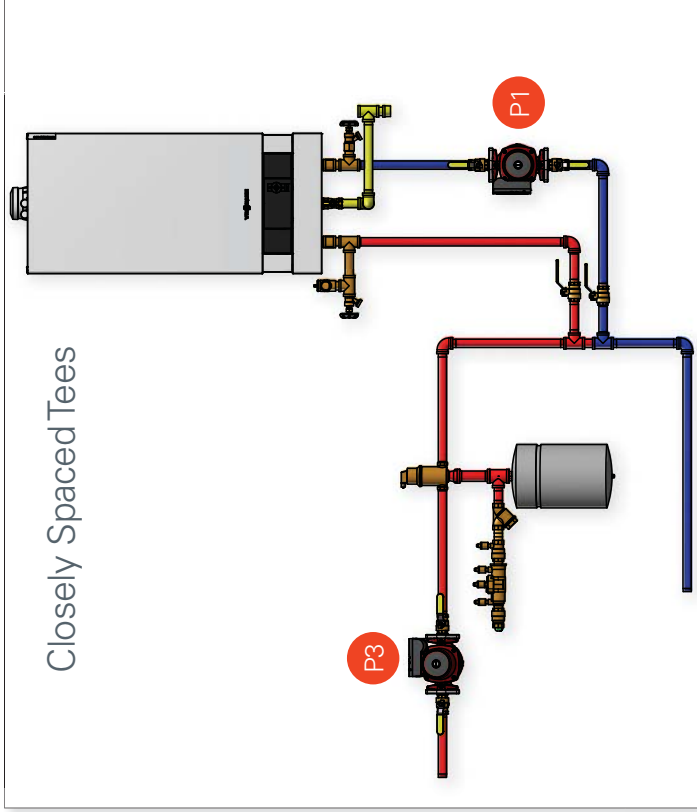
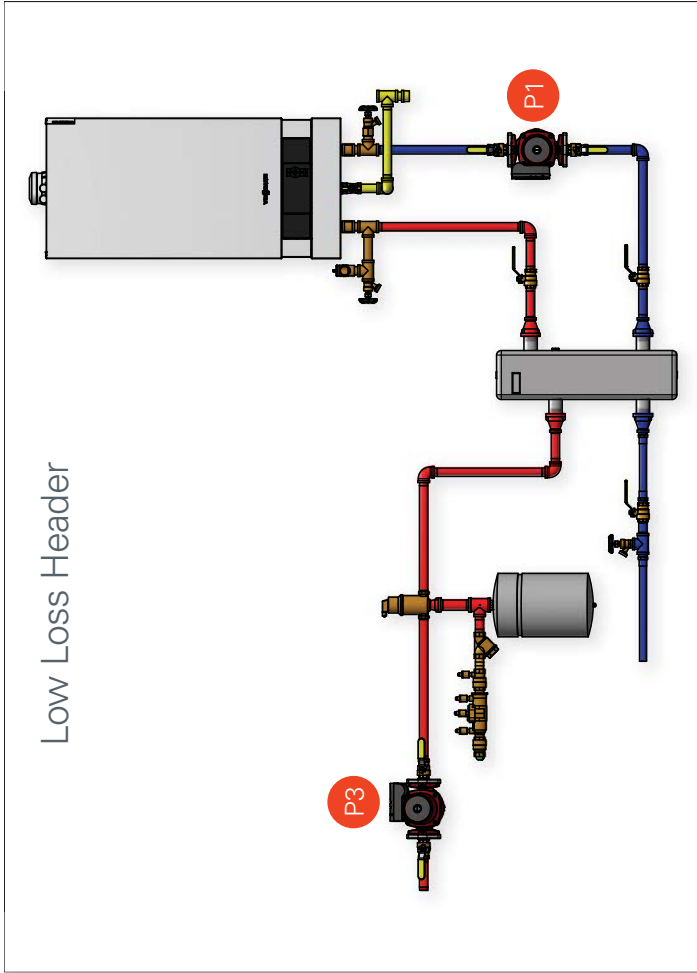

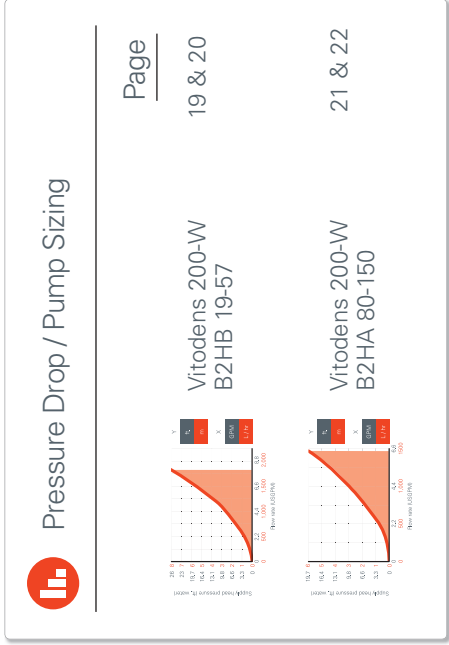

Notes/Comments

- Hydraulically separating the flow of the boiler and system with closely spaced tees or a low loss header, ensures that the boiler and system flows do not affect each other.
- Because of the flow restriction through the boiler, it is recommended to install the P1 circulator on the return water side of the boiler.
- Refer to component index on Page 5.

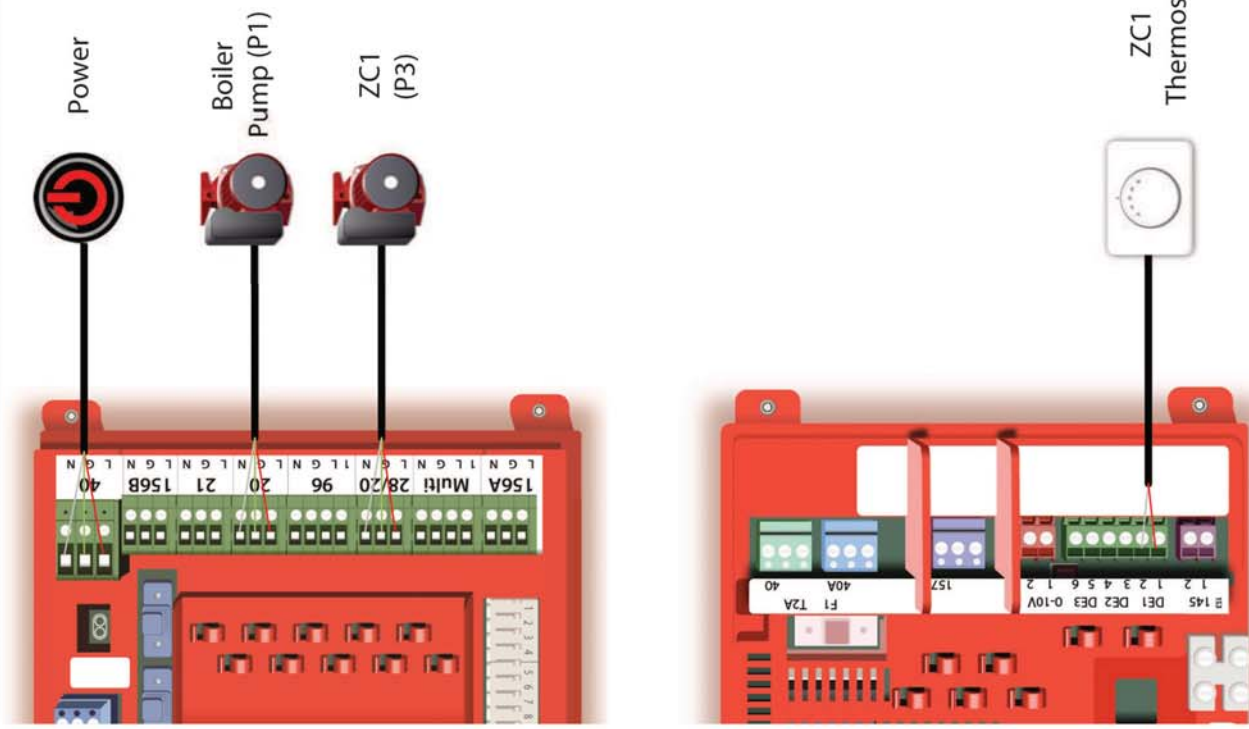

Application Code
 VD2X 1ZC1ZP.01



 Application Code VD2X 1ZC1ZP.01	 Notes/Comments
---	---

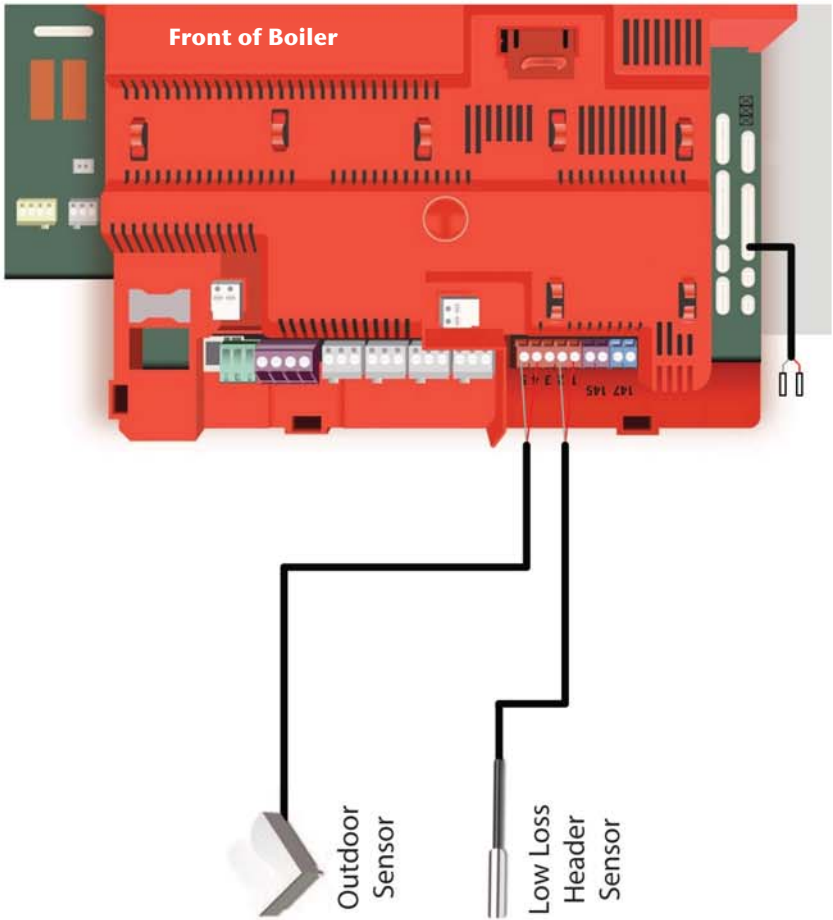

Zone Control Wizard Setup 1 Zone Circuit: Fixed Set Point OR Weather Compensated

This particular application represents a low mass boiler with a single system loop. Because the system flow requirements may vary or fall outside of the parameters of the boiler's recommended flow, it is beneficial to hydraulically separate the system flow from the boiler flow. This can be achieved by using a low loss header or closely spaced tees on the system loop. A low loss header sensor can be installed allowing better system control and increased efficiency. A ZC1 thermostat call will be sensed by the EA1 module and turn on the configured 28/20 P3 pump providing the necessary flow. Depending on the ZC1 configuration, it is possible to provide either a fixed setpoint or a weather compensated control option.

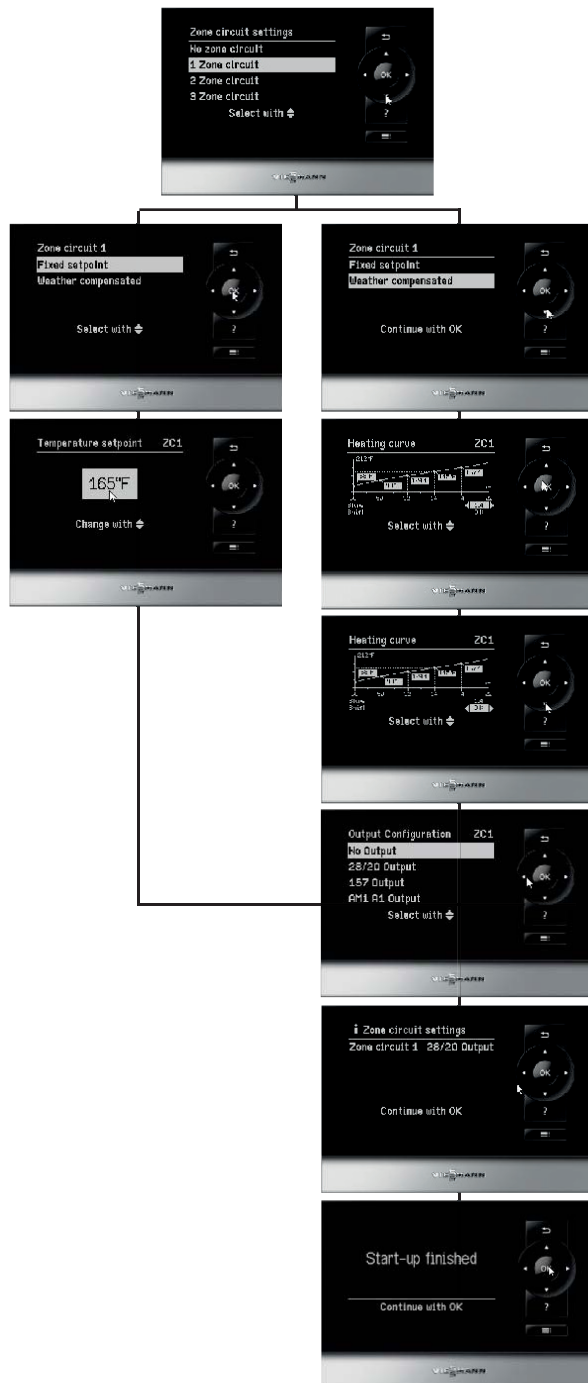

Select the correct number of Zone Circuit connections with respect to the number of thermostats connected to the DE connections. Press OK

Depending on how the zone temperature set point is determined, select either Fixed Setpoint or Weather Compensated. Adjustments to either setting will follow.

Fixed Setpoint: Enter the value that is to be used by the boiler as a target water temperature when there is a call for heat.

Weather Compensated: The Slope and Shift settings can be adjusted to allow a heating curve to be set. When there is a zone heat demand, the calculated set point will be used as long as the demand is present.

Select the desired pump output that will be enabled during a ZC call. When there is a call, the output will be energized for the duration of the call.

The zone circuit setting output summary shows the selected pumps depending on the number of zones selected in the very beginning.

The Start-up is finished and boiler is ready for operation.

Further Considerations

DHW Production

Set timer schedule as desired. If DHW production possible at any time, program timer settings to 0:00 to 24:00

DHW Recirculation Pump

Set recirculation pump timer as desired for pump connected to 28/20 output

DHW production from system side of low loss header, address 5B will need to be changed from a value of 0 to 1.

DHW priority can be removed by changing address A2 to a value of 0.

Boiler pump operation can be modified with address 51 by setting to a value of 1. When there is a demand for heat, the boiler pump will turn on and then turn off after the demand has been removed and post purge time. This is based on having a low loss header temperature sensor installed.

The HC1 settings are still available should an outdoor reset based zone be connected. Should mixing valve extension kits be used, adjust the outdoor reset settings as required.

Notes/Comments

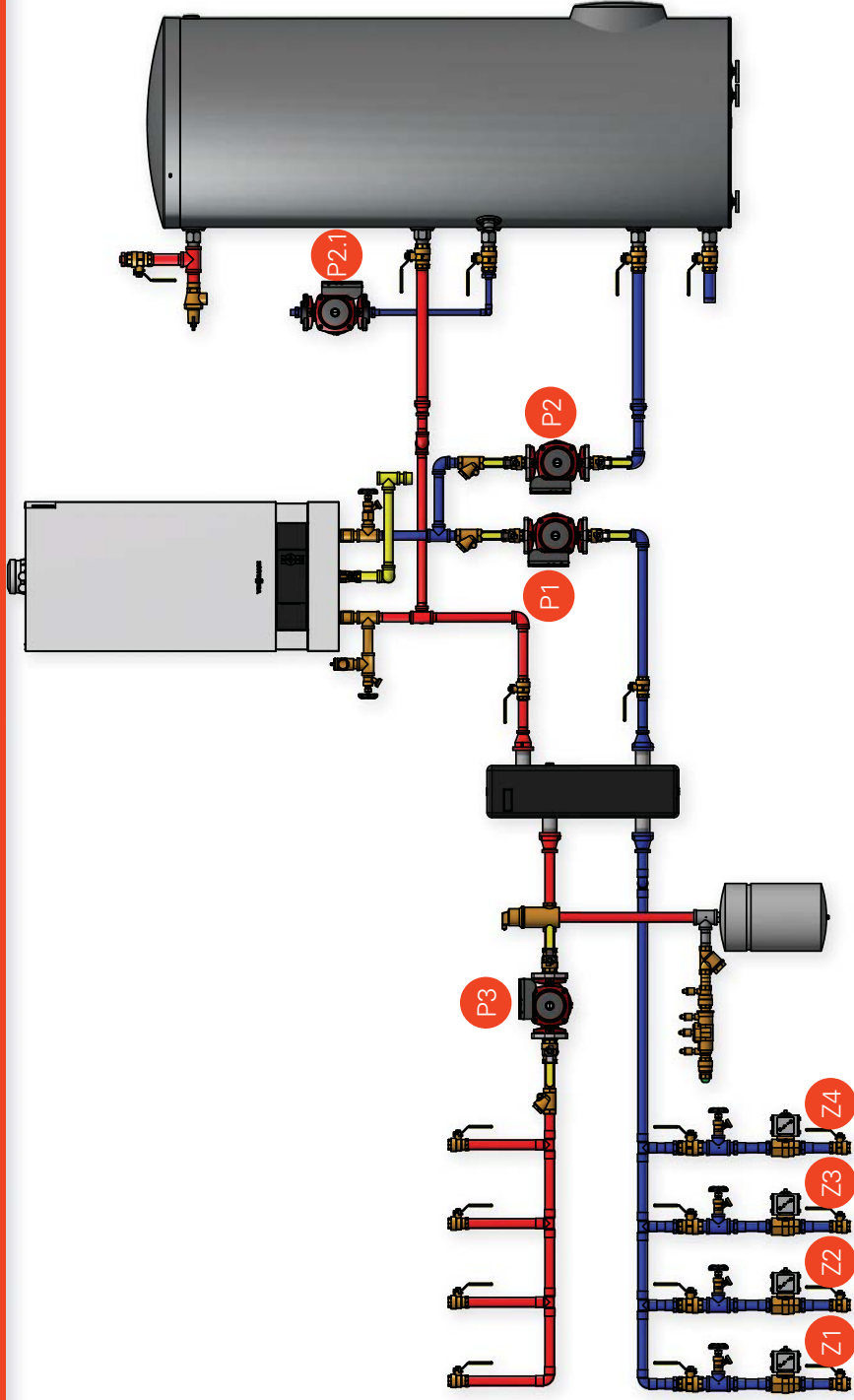

Notes / Comments

1. P3 Zone pump powered by 157 output of EA1 module from configuration of Zone Circuit 1.
2. If a single speed circulator is being utilized, a pressure differential bypass is recommended to prevent increased circulation when a single zone valve opens.
3. A variable speed circulator will automatically adjust to opening and closing zones. This ensures proper flow regardless of how many zones are open.



Pressure Drop / Pump Sizing

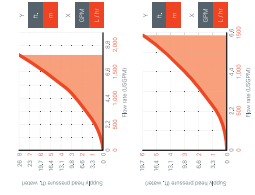

Page

19 & 20

Vitodens 200-W
B2HB 19-57

21 & 22

Vitodens 200-W
B2HA 80-150



Application Code

VD21 1ZC4ZV.01

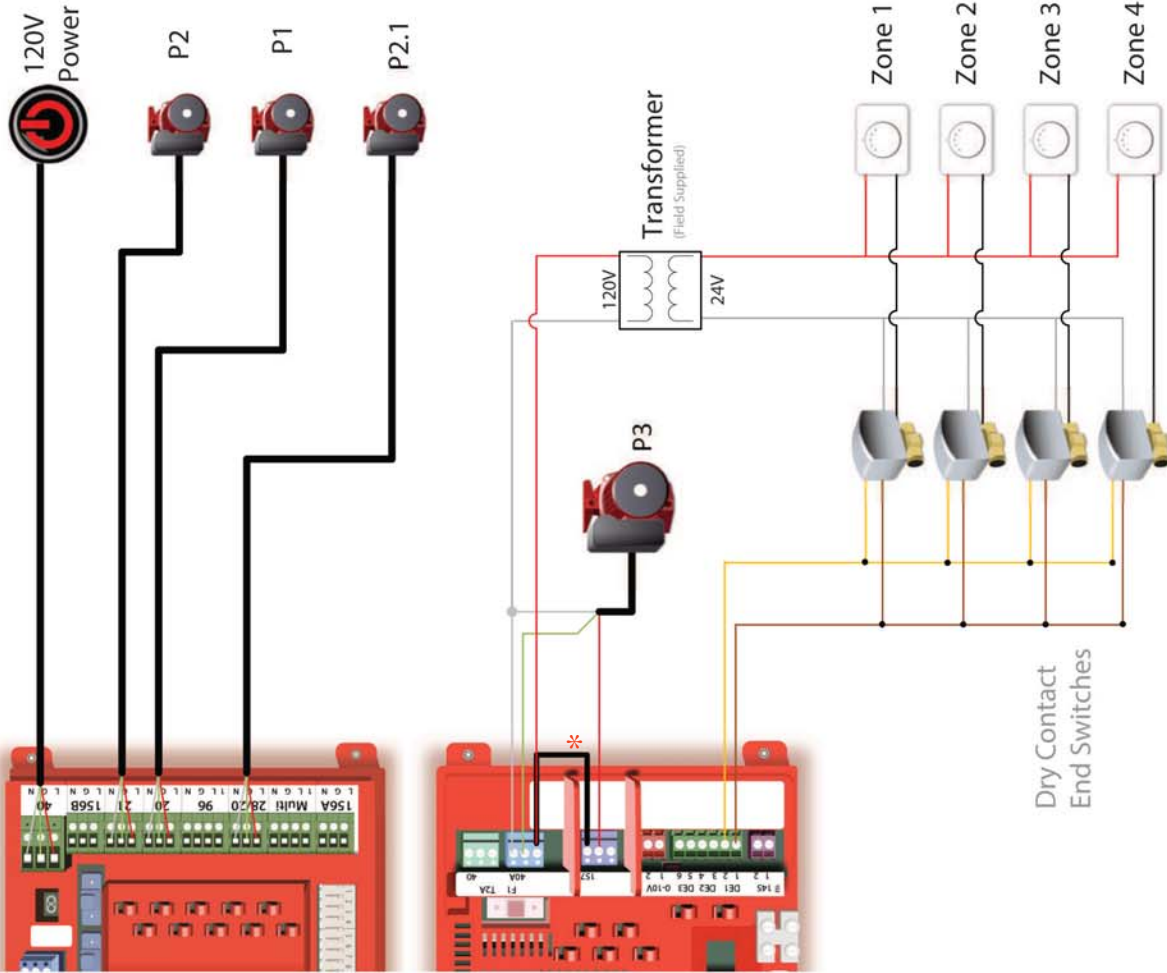

 Application Code
VD21 1ZC4ZV.01

 Notes / Comments

1. P3 Zone pump powered by 157 output of EA1 module from configuration of Zone Circuit 1.
2. Don't forget about the jumper between the 40A and the 157 Plug (*).

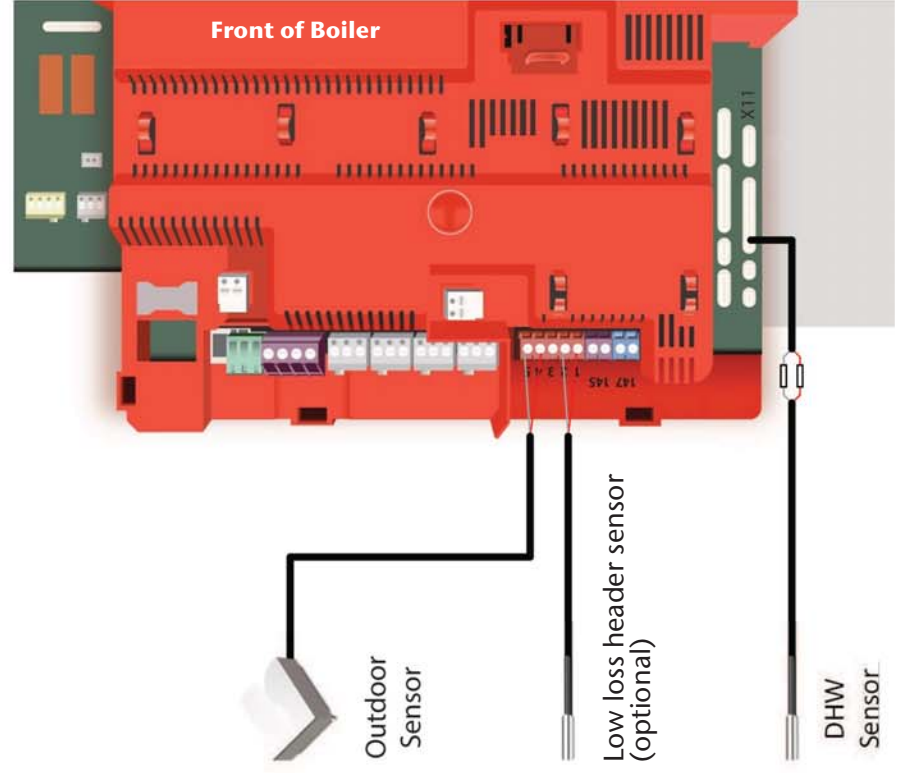

Zone Control Wizard Setup 1 Zone Circuit: Fixed Set Point with 157 Pump Output

In this system you have a Vitodens 200 with an indirect water heater and a four-zone single temperature system. Upon a call for heat from one of the four zone thermostats, the respective zone valve will open. The end switch will provide a demand input DE1 of the EA1 module. The 157 plug connected P3 pump will turn on and the boiler will use the ZC set point to provide a target boiler water temperature. In the event there is a call for DHW, the P1 circulator will turn off and P2 will be engaged. This will provide a domestic priority function for the purpose of quickly satisfying a DHW demand. It is recommended to use a variable speed circulator for P3 that will adjust flow based on opening/closing zone valves. If a single speed pump is being used, ensure a pressure differential bypass is incorporated into the system to avoid "over pumping" a single circuit when a zone is calling for heat.

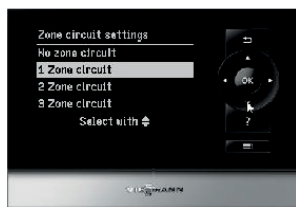

Since this particular application is a single temperature circuit, select 1 Zone Circuit from the menu options.



This application is based on a Fixed Setpoint temperature during a zone call for heat. Press OK to confirm selection.



Enter the value that is to be used by the boiler as a target water temperature where there is a call for heat. You can adjust the values by arrowing down or up to the correct set point value and press OK.

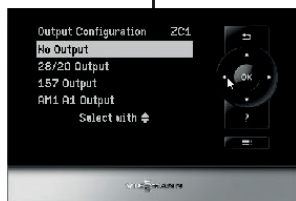

The pump based on this application is controlled by the 157 output. Arrow down until 157 Output is highlighted and press OK.

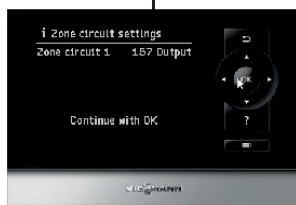

The zone circuit setting output summary shows the selected pumps depending on the number of zones selected in the very beginning. Press OK to continue.



The Start-up is finished and boiler is ready for operation. Press OK to continue



Notes/Comments

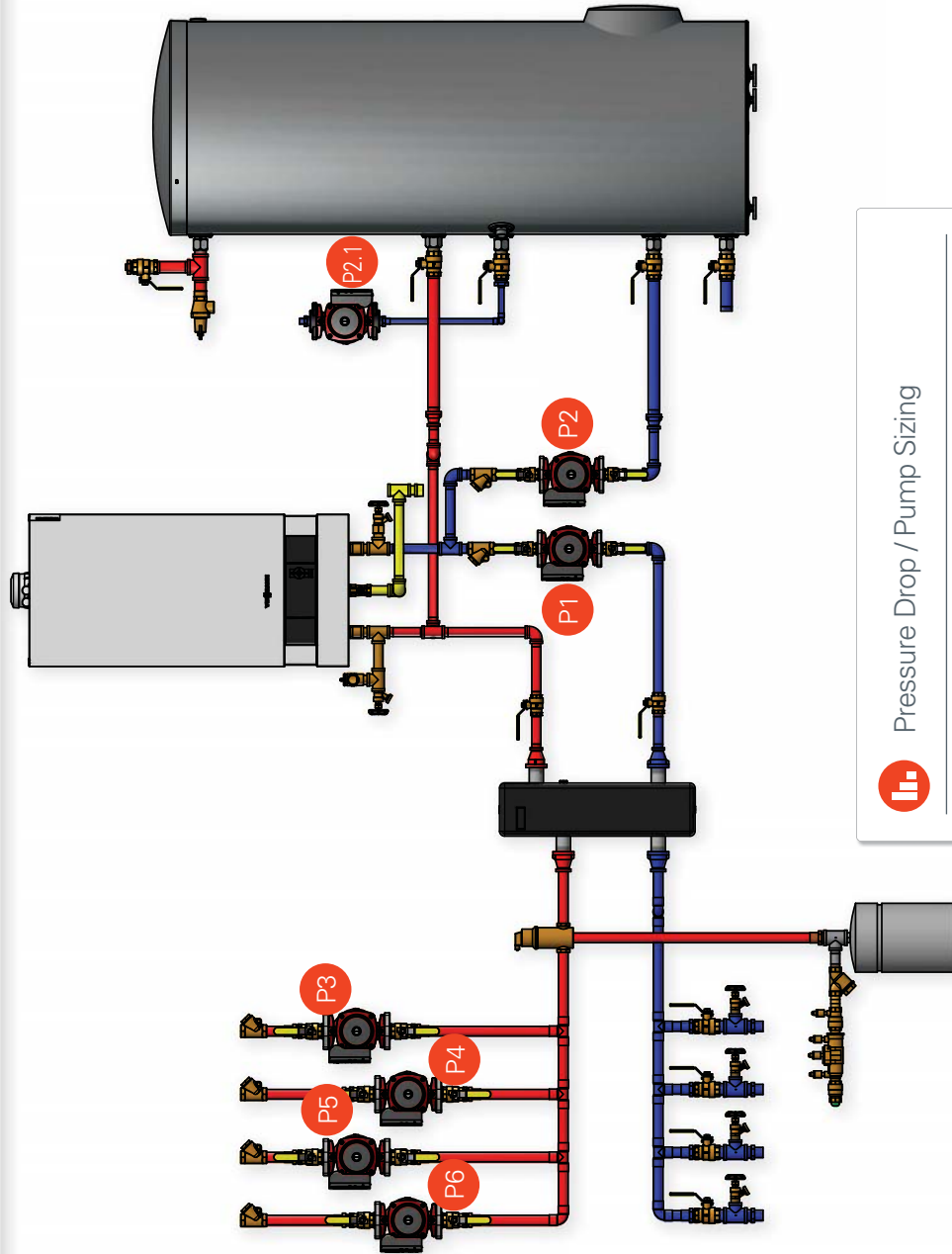

Notes/Comments

1. Reference component index on page 5.
2. Always consider the electrical consumption associated with zoning a system with circulators. Often there are more efficient alternatives which could be considered when designing a system.



Pressure Drop / Pump Sizing

Page

19 & 20

Vitodens 200-W
B2HB 19-57

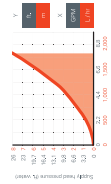

21 & 22

Vitodens 200-W
B2HA 80-150

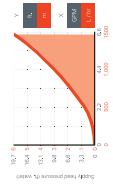

Application Code

VD2I 1ZC4ZP.01

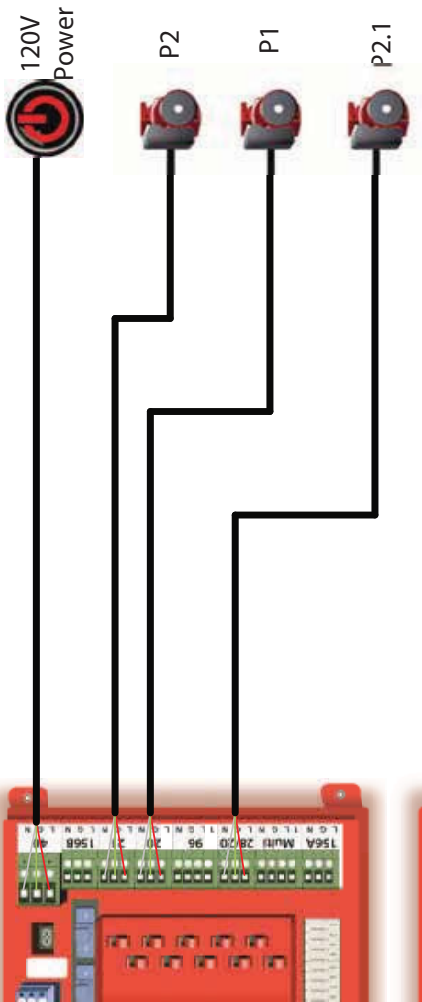

 Application Code
VD21 1ZC4ZP:01

 Notes / Comments

1. There are no configured pumps with respect to the Zone Circuit configuration. Pumps are controlled by the Multizone Control.

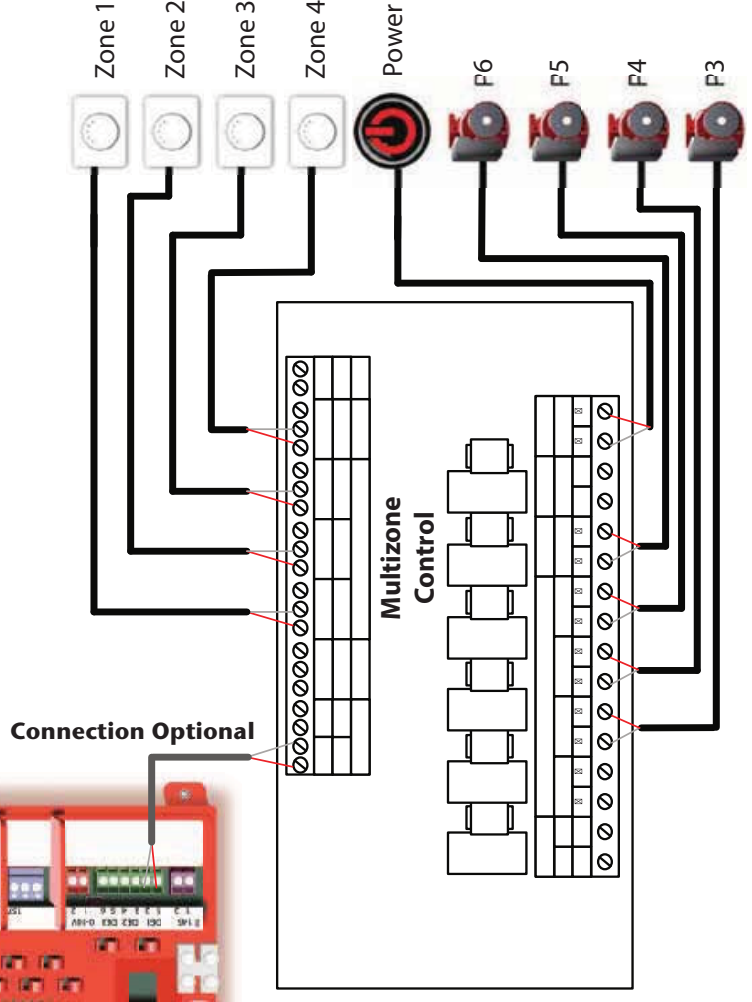
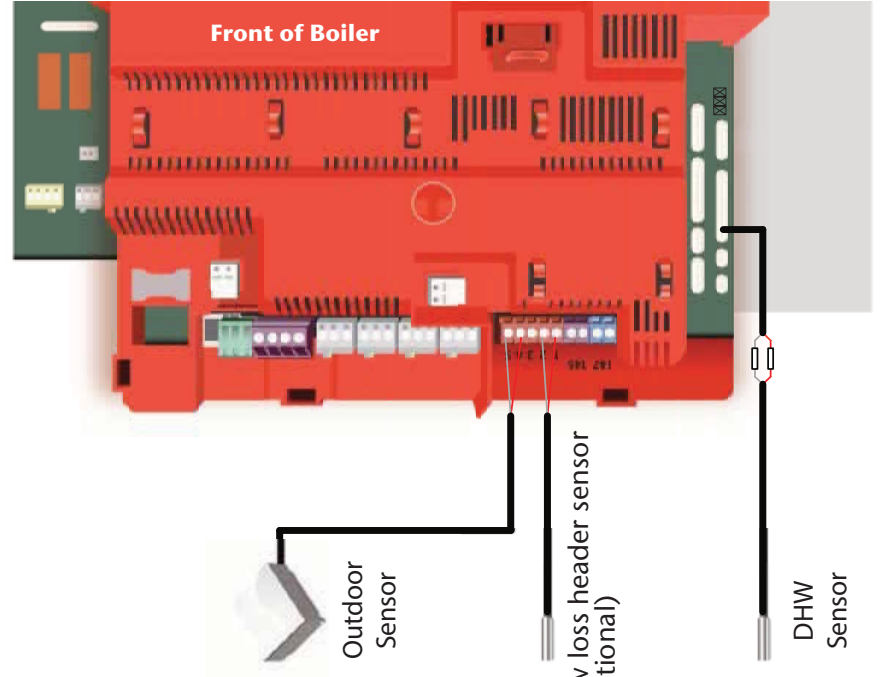

Zone Control Wizard Setup 1 Zone Circuit: Fixed Set Point w/no configured pump output

If you are zoning with pumps, consider this application for your next install. This system shows a Vitodens 200 with an indirect water heater and a four zone single temperature system. Upon a call for heat from a thermostat, the associated zone pump is energized by the multi-zone control. The connection of the heat demand output of the Multizone Control will provide a demand to the DE1 of the EA1 module generating a ZC1 set point demand. This is a very simple control solution for single temperature applications.

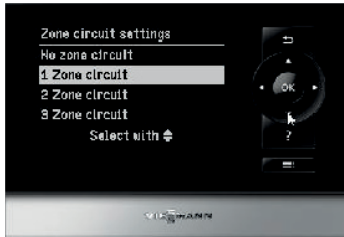

Since this particular application is a single temperature circuit, select 1 Zone Circuit from the menu options.



This application is based on a Fixed Setpoint temperature during a zone call for heat. Press OK to confirm selection.



Enter the value that is to be used by the boiler as a target water temperature where there is a call for heat. You can adjust the values by arrowing down or up to the correct set point value and press OK.

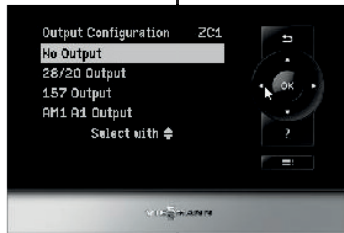

There is no assigned pump for this application. Pressing the OK button will not assign any specific pump output



The zone circuit summary indicates no pumps selected.



The Start-up is finished and boiler is ready for operation. Press OK to continue

Further Considerations

DHW Production

Set timer schedule as desired. If DHW production possible at any time, program timer settings to 0:00 to 24:00

DHW Recirculation Pump

Set recirculation pump timer as desired for pump connected to 28/20 output

DHW production from system side of low loss header, address 5B will need to be changed from a value of 0 to 1.

DHW priority can be removed by changing address A2 to a value of 0.

Boiler pump operation can be modified with address 51 by setting to a value of 1. When there is a demand for heat, the boiler pump will turn on and then turn off after the demand has been removed and post purge time. This is based on having a low loss header temperature sensor installed.

The HC1 settings are still available should an outdoor reset based zone be connected. Should mixing valve extension kits be used, adjust the outdoor reset settings as required.

Notes/Comments

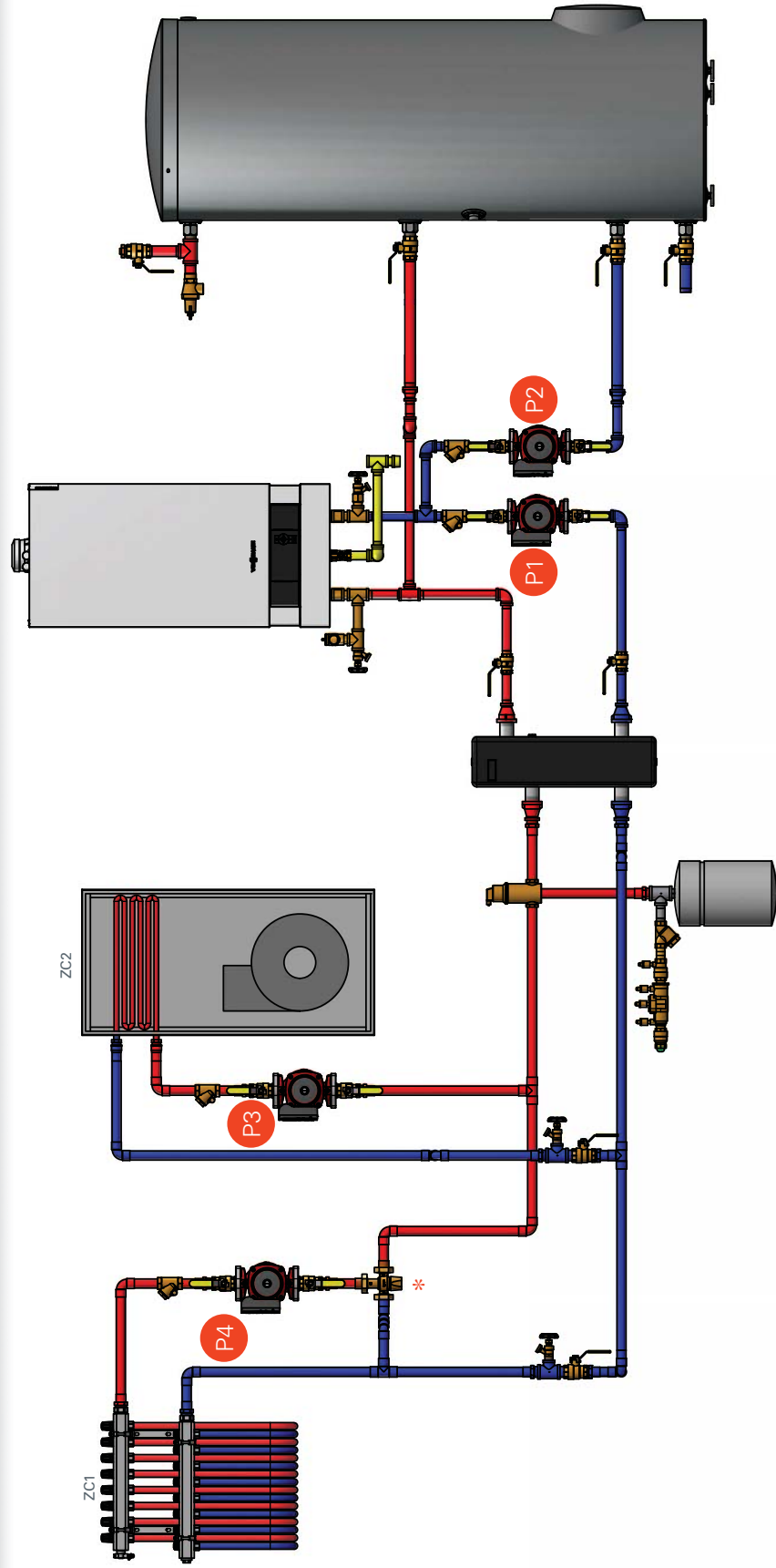

Notes / Comments

1. A thermostatic mixing valve should be installed to protect the radiant floor heating from receiving excessive hot water. (* shown above)
2. Component index on page 5.



Pressure Drop / Pump Sizing

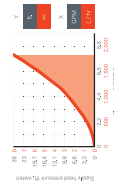

Vitodens 200-W
B2HB 19-57

Page

19 & 20

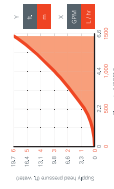

Vitodens 200-W
B2HA 80-150

Page

21 & 22



Application Code

VD2I 2ZC2ZP01

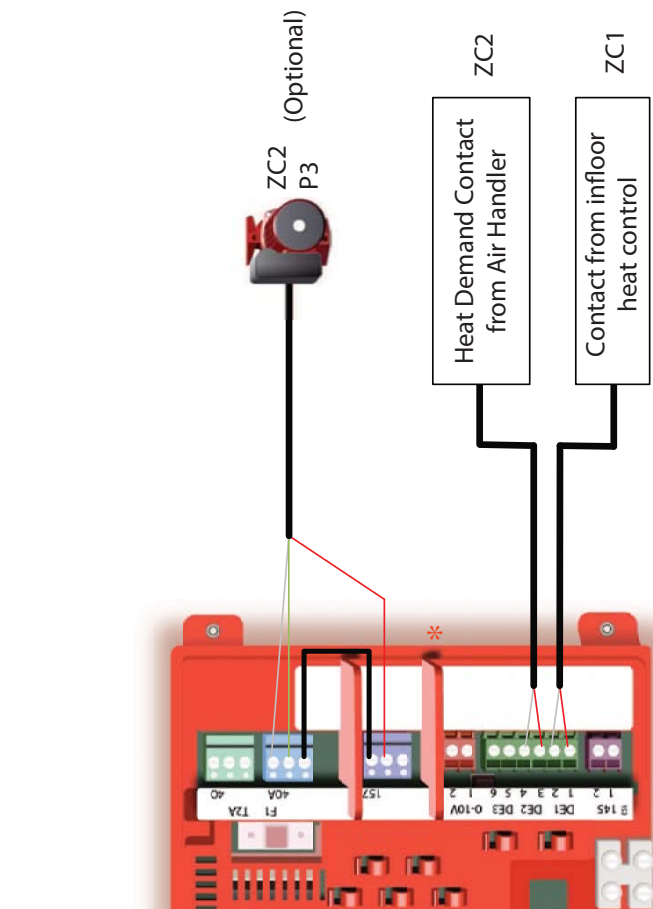
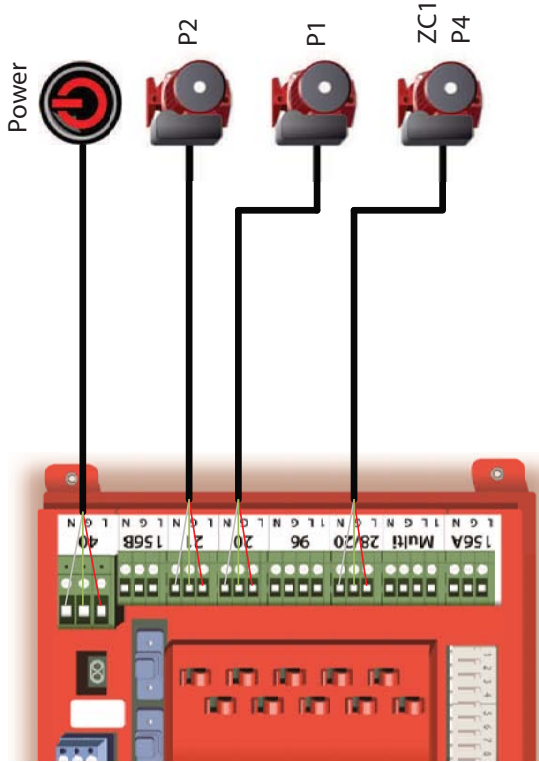

Application Code
VD21 2ZC2ZP:01

- Notes / Comments
1. Heat demand contact from air handler must be a dry contact / potential free.
 2. The dry contact for the radiant heat circuit could come from a device such as a thermostat, zone valve, or multi zone controller.
 3. Don't forget about the jumper between the 40A plug and the 157 Plug. (*)
 4. If P3 is controlled by the air handler, no pump wiring is necessary.

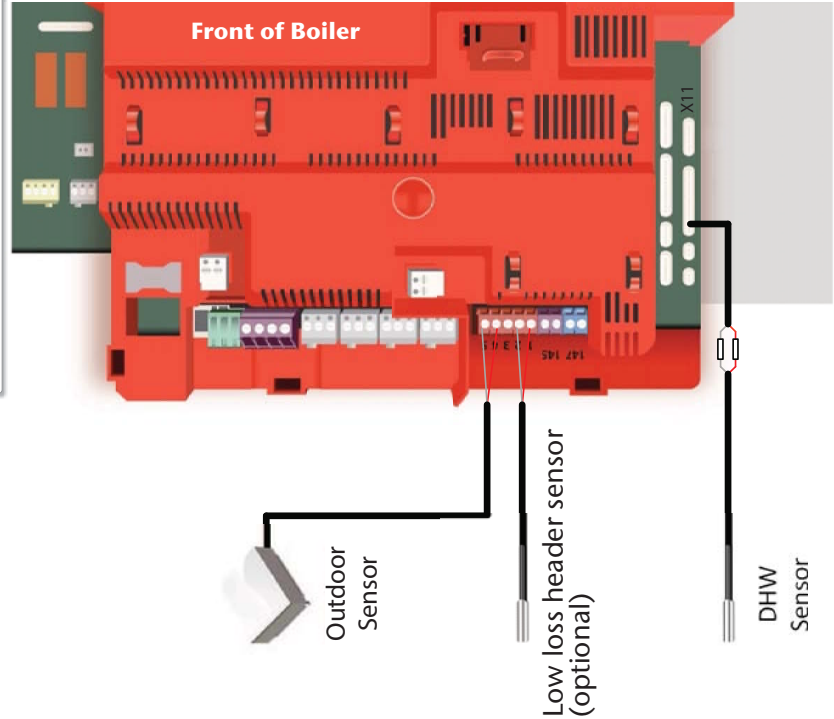

Zone Control Wizard—2 ZC—ZC1 Setpoint Demand with ZC2 Weather Compensated

This application features two heat circuits which operate at different temperatures. This particular drawing portrays ZC1 as a low temperature circuit and the air handler as a mid/high temperature circuit, ZC2. Although there are many different configurations, the setup below will operate ZC1 as an on/off function where an outdoor reset curve will be enabled during a thermostat call. The ZC2 air handler will operate on a constant temperature setpoint also referred to as a Fixed Setpoint. It is important to provide a method of protecting the ZC1 from high water temperatures when the air handler is operating, so don't forget to include the thermostatic mixing valve. The ZC1 shown here is configured with pump output 28/20 and the ZC2 call will bring on the 157 plug connected pump should there be a call for heat.

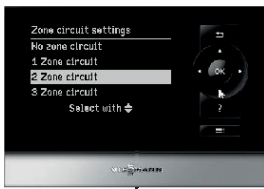

Select the correct number of Zone Circuit connections with respect to the number of thermostats connected to the DE connections. Press OK

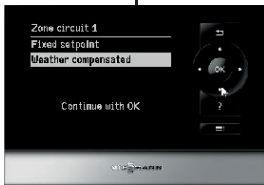

This application is based on a Weather Compensated, arrow down and press OK to confirm setting.



The Slope and Shift settings can be adjusted to allow a heating curve to be set. When there is a zone heat demand, the calculated set point will be used as long as the demand is present. Arrow up or down to move to the shift setting from slope. Making an adjustment of either setting will graphically indicate how the heating curve moves.

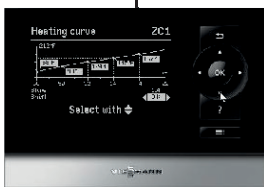

Once the settings have been made, press OK to continue. These settings can be easily adjusted later on should they need to be changed.



The ZC1 pump for this particular application is the 28/20 pump. Pressing OK continues to the ZC2 circuit,



The Zone Circuit 2 is to be set for Fixed Setpoint temperature demand. Press OK to select and continue. The next screen allows for a set point adjustment of the zone target temperature



The final step in this application configuration is to select the associated pump for ZC2. Select the 157 Output and press OK.

Following will be the output summary and the start up configuration is finished



Notes/Comments

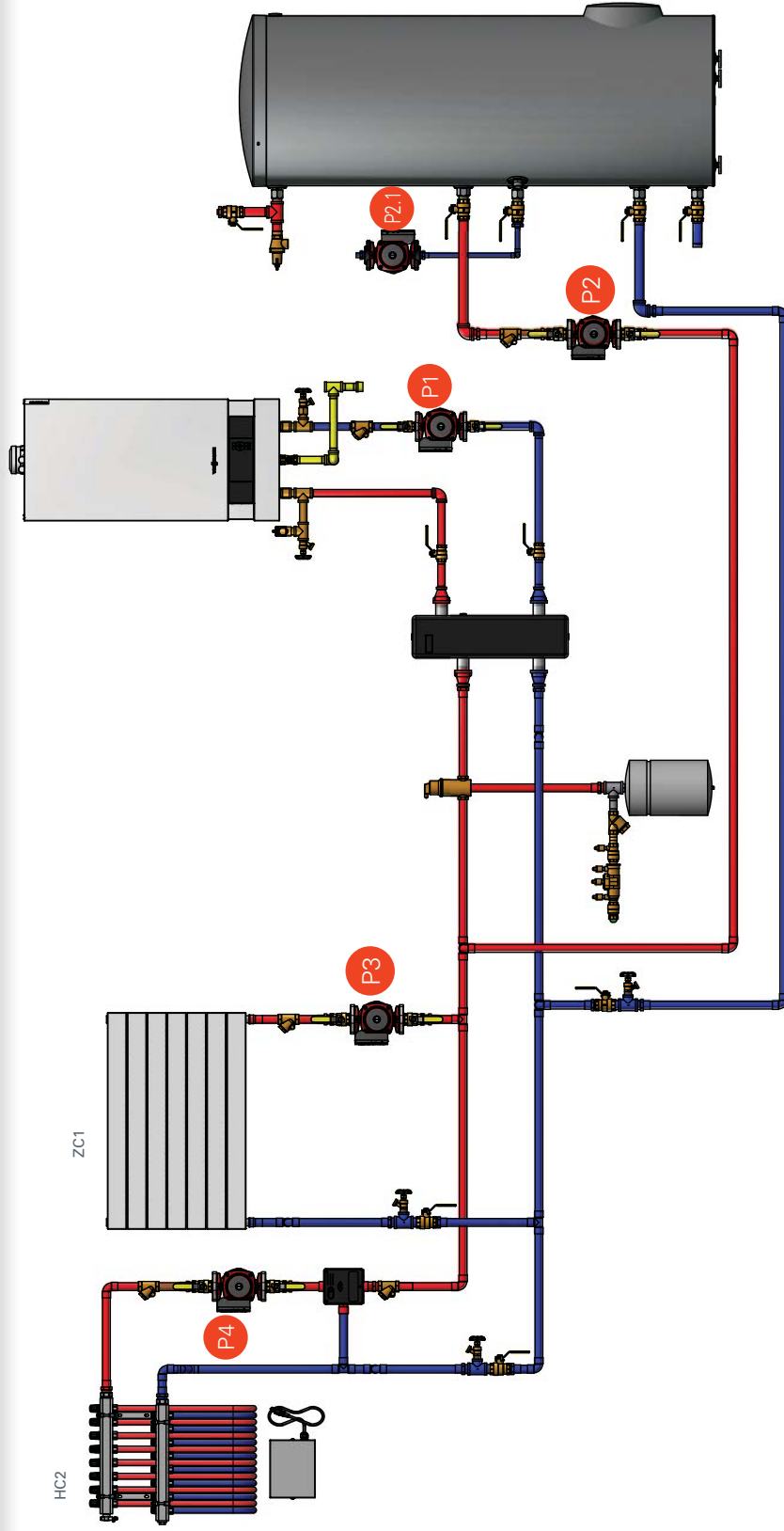

Notes / Comments

1. A thermostatic mixing valve may be required on the radiator loop to prevent excessive hot water supply to the circuit when the DHW is calling for heat.
2. Component Index on pages 5.
3. When the indirect DHW tank is part of the system load, consideration must be given to the size of the boiler in order to allow for simultaneous operation of space heating and DHW.



Pressure Drop / Pump Sizing

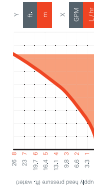

Vitodens 200-W
B2HB 19-57

Page

19 & 20

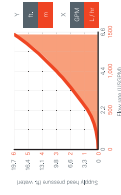

Vitodens 200-W
B2HA 80-150

21 & 22



Application Code

VD2| 3HC/ZC3ZP.01

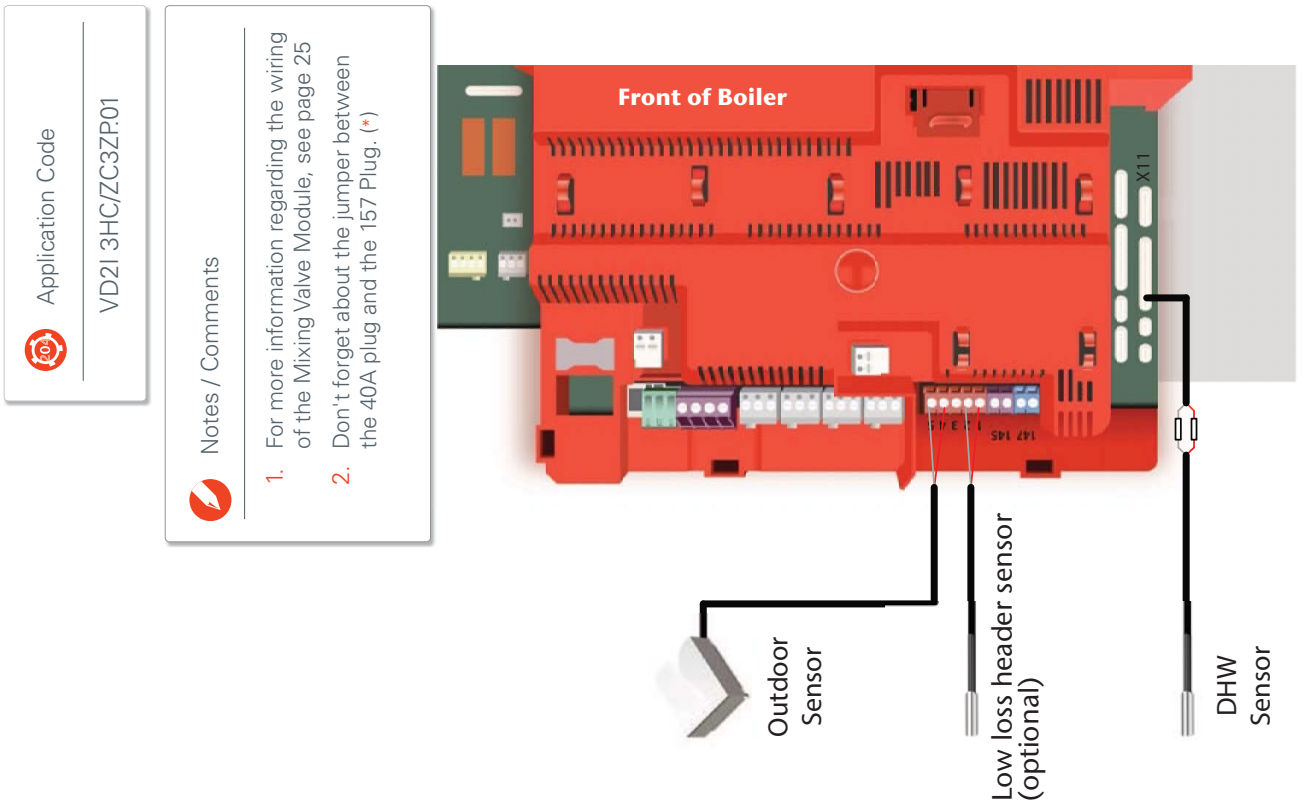
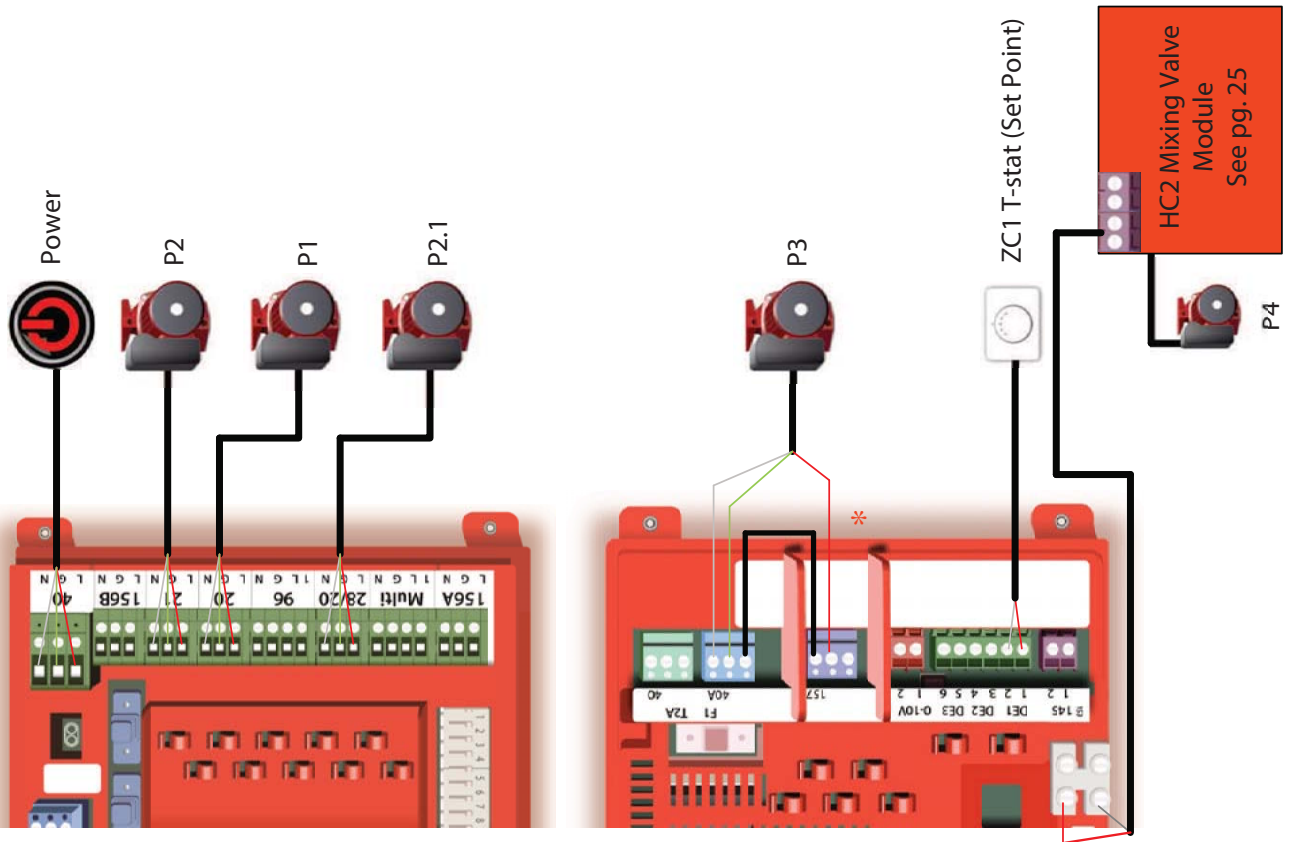

Application Code
VD21 3HC/ZC3ZP:01

Notes / Comments

1. For more information regarding the wiring of the Mixing Valve Module, see page 25
2. Don't forget about the jumper between the 40A plug and the 157 Plug. (*)

Zone Control Wizard Setup 1 Zone Circuit: Fixed Set Point with 157 Pump Output

This application shows a low temperature heat circuit with 3-way mixing valve, a high temperature heating circuit ZC1 and an indirect DHW piped on the system side of the low loss header. This application allows for simultaneous operation of both space heating and DHW, just remember to size your boiler accordingly. A ZC1 call will turn on the configured 157 plug connected pump providing flow for the high temperature zone. The HC2 mixing valve will operate from heating curve settings, set within the boiler control.

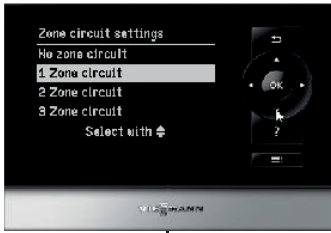

Select the correct number of Zone Circuit connections with respect to the number of thermostats connected to the DE connections. Press OK



This application is based on a Fixed Setpoint temperature during a zone call for heat. Press OK to confirm selection.



Enter the value that is to be used by the boiler as a target water temperature where there is a call for heat. You can adjust the values by arrowing down or up to the correct set point value and press OK.

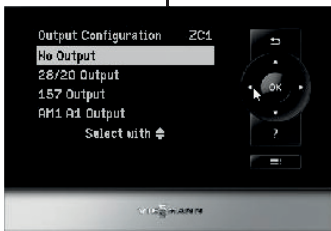

The pump based on this application is controlled by the 157 output. Arrow down until 157 Output is highlighted and press OK.

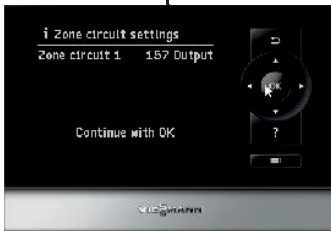

The zone circuit setting output summary shows the selected pumps depending on the number of zones selected in the very beginning. Press OK to continue.



The Start-up is finished and boiler is ready for operation. Press OK to continue

Further Considerations

DHW Production

Set timer schedule as desired. If DHW production possible at any time, program timer settings to 0:00 to 24:00

DHW Recirculation Pump

Set recirculation pump timer as desired for pump connected to 28/20 output

DHW production from system side of low loss header, address 5B will need to be changed from a value of 0 to 1.

DHW priority can be removed by changing address A2 to a value of 0.

Boiler pump operation can be modified with address 51 by setting to a value of 1. When there is a demand for heat, the boiler pump will turn on and then turn off after the demand has been removed and post purge time. This is based on having a low loss header temperature sensor installed.

The HC1 settings are still available should an outdoor reset based zone be connected. Should mixing valve extension kits be used, adjust the outdoor reset settings as required.

Notes/Comments

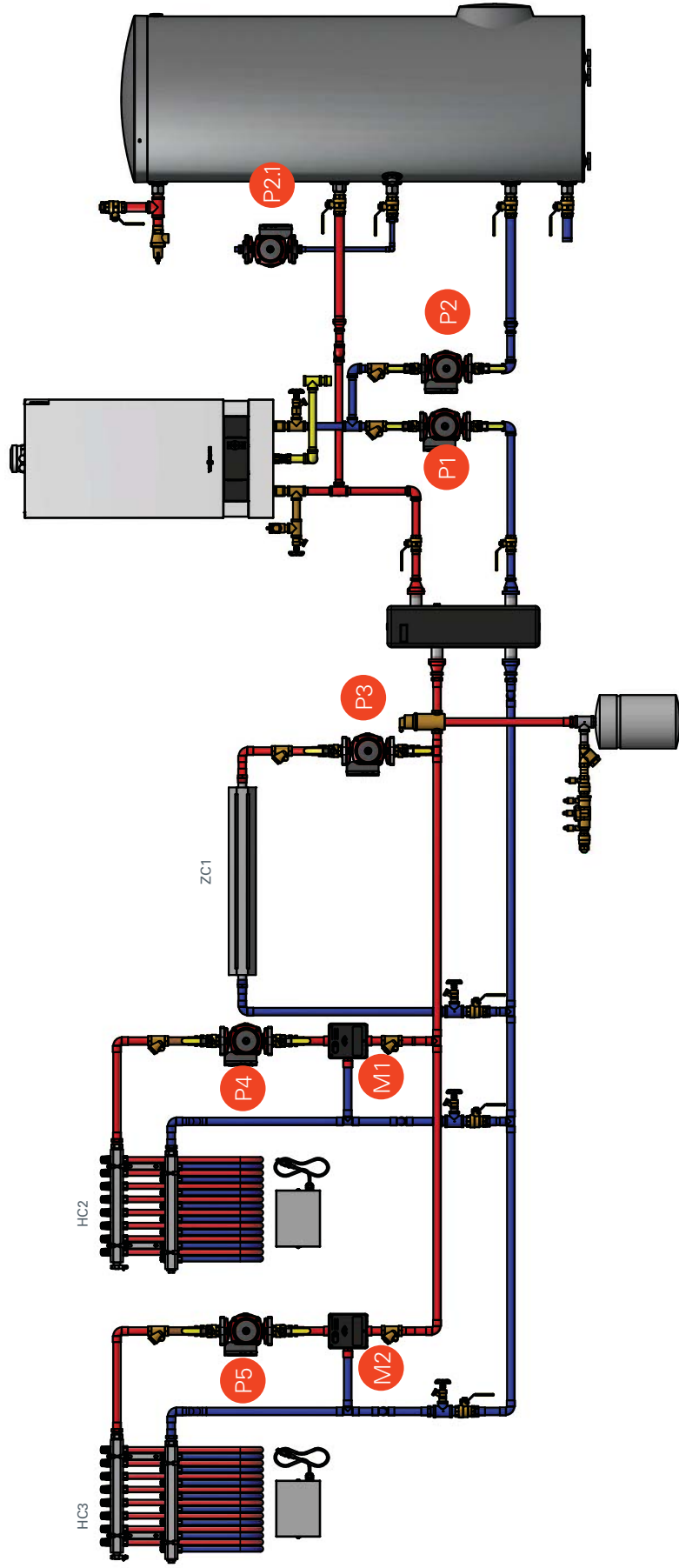

Notes / Comments

1. Component Index on pages 5.
2. External flow check valves are not necessary if built into the circulators.



Pressure Drop / Pump Sizing

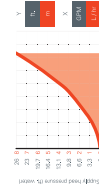

Vitodens 200-W
B2HB 19-57

Page
19 & 20

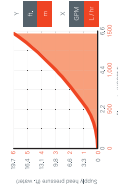

Vitodens 200-W
B2HA 80-150

Page
21 & 22



Application Code
VD21 3HC/ZC3ZP02

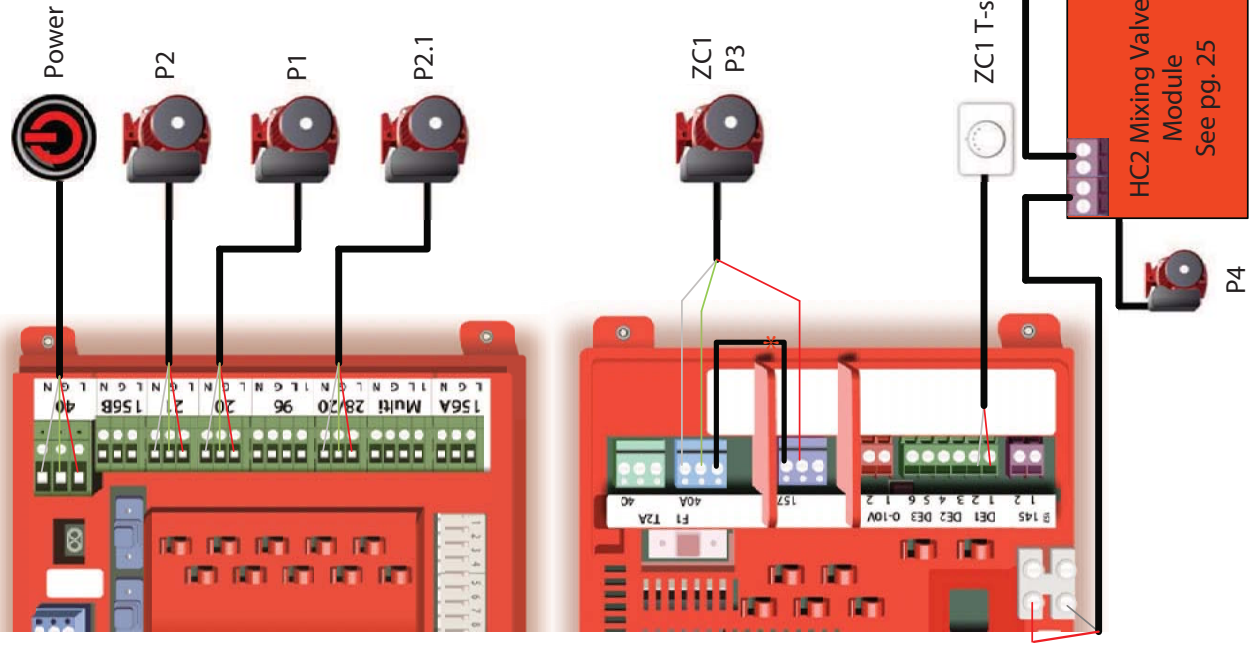

Application Code
 VD21 3HC/ZC3ZP02

Notes / Comments
 1. Jumper must be installed between the 40A plug and the 157 Plug. (*)

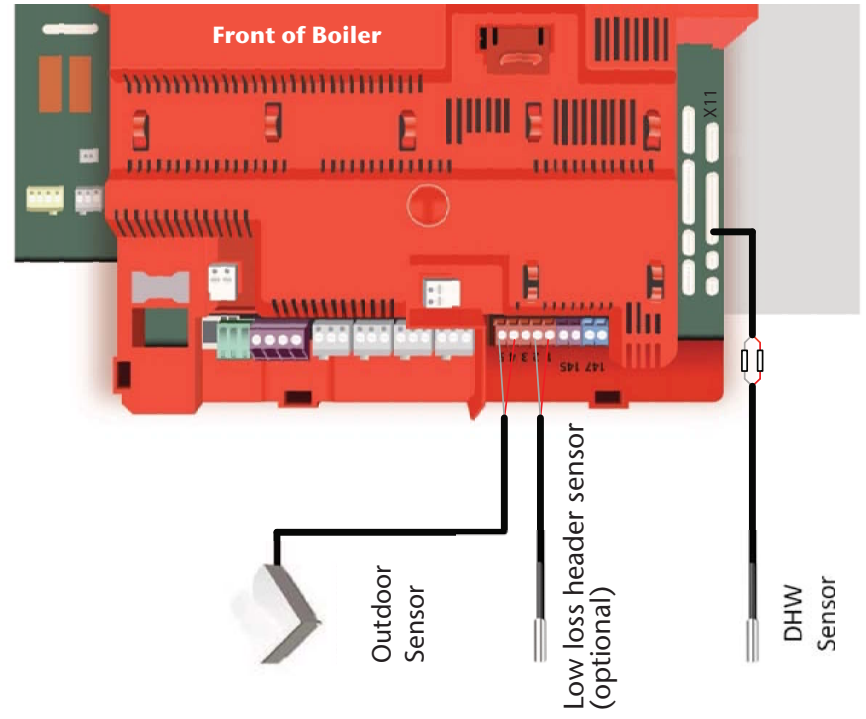

Zone Control Wizard Setup 1 Zone Circuit: Fixed Set Point with 157 Pump Output

This application shows 2 heat circuits with mixing valves, a high temperature heat circuit, and an indirect DHW on the primary side of the low loss header. This system approach maximizes system efficiency, control and comfort through precise water monitoring. The ZC1 thermostat call for heat will enable 157 plug to power the P3 pump providing flow in the unmixed temperature heating circuit. The ZC1 circuit can be configured to operate based on a Fixed Setpoint demand temperature or a Weather Compensated demand. The HC2 and HC3 mixing valve controls will operate based on heat curve settings from within the boiler.

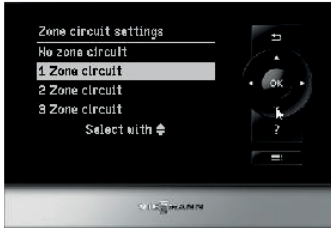

Select the 1 Zone Circuit with respect to the ZC thermostat connected to the DE connections. Press OK



This application is based on a Fixed Setpoint temperature during a zone call for heat. Press OK to confirm selection.



Enter the value that is to be used by the boiler as a target water temperature where there is a call for heat. You can adjust the values by arrowing down or up to the correct set point value and press OK.

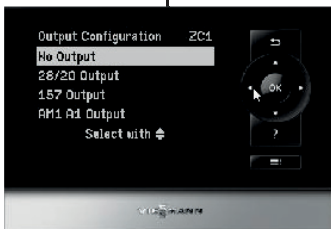

The pump based on this application is controlled by the 157 output. Arrow down until 157 Output is highlighted and press OK.

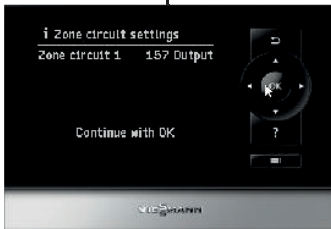

The zone circuit setting output summary shows the selected pumps depending on the number of zones selected in the very beginning. Press OK to continue.



The Start-up is finished and boiler is ready for operation. Press OK to continue



Notes/Comments

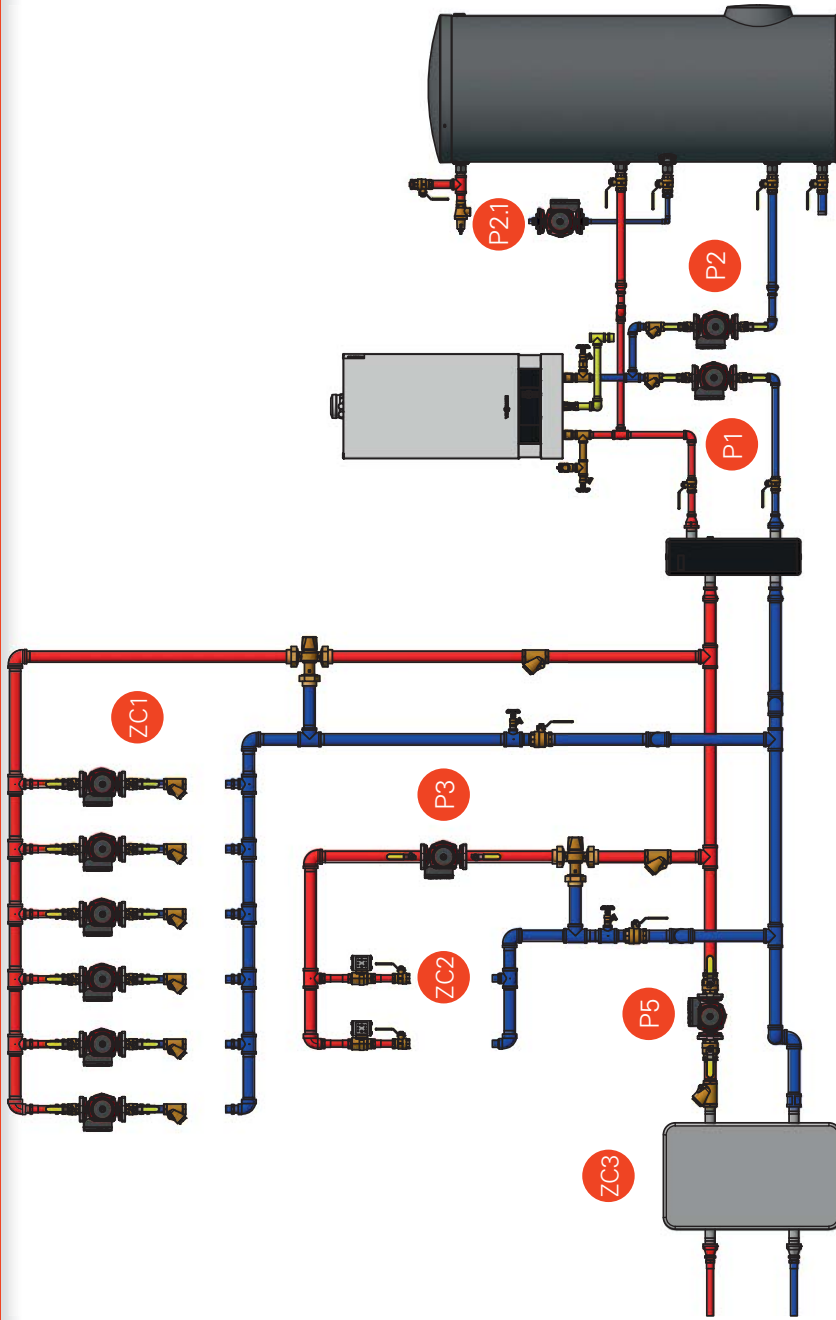

Notes / Comments

1. Component Index on pages 5.
2. External flow check valves are not necessary if built into the circulators.



Pressure Drop / Pump Sizing

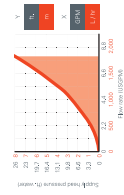

Vitodens 200-W
B2HB 19-57

Page

19 & 20

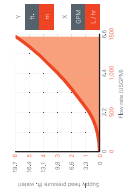

Vitodens 200-W
B2HA 80-150

21 & 22



Application Code

VD21 3ZC9C.01

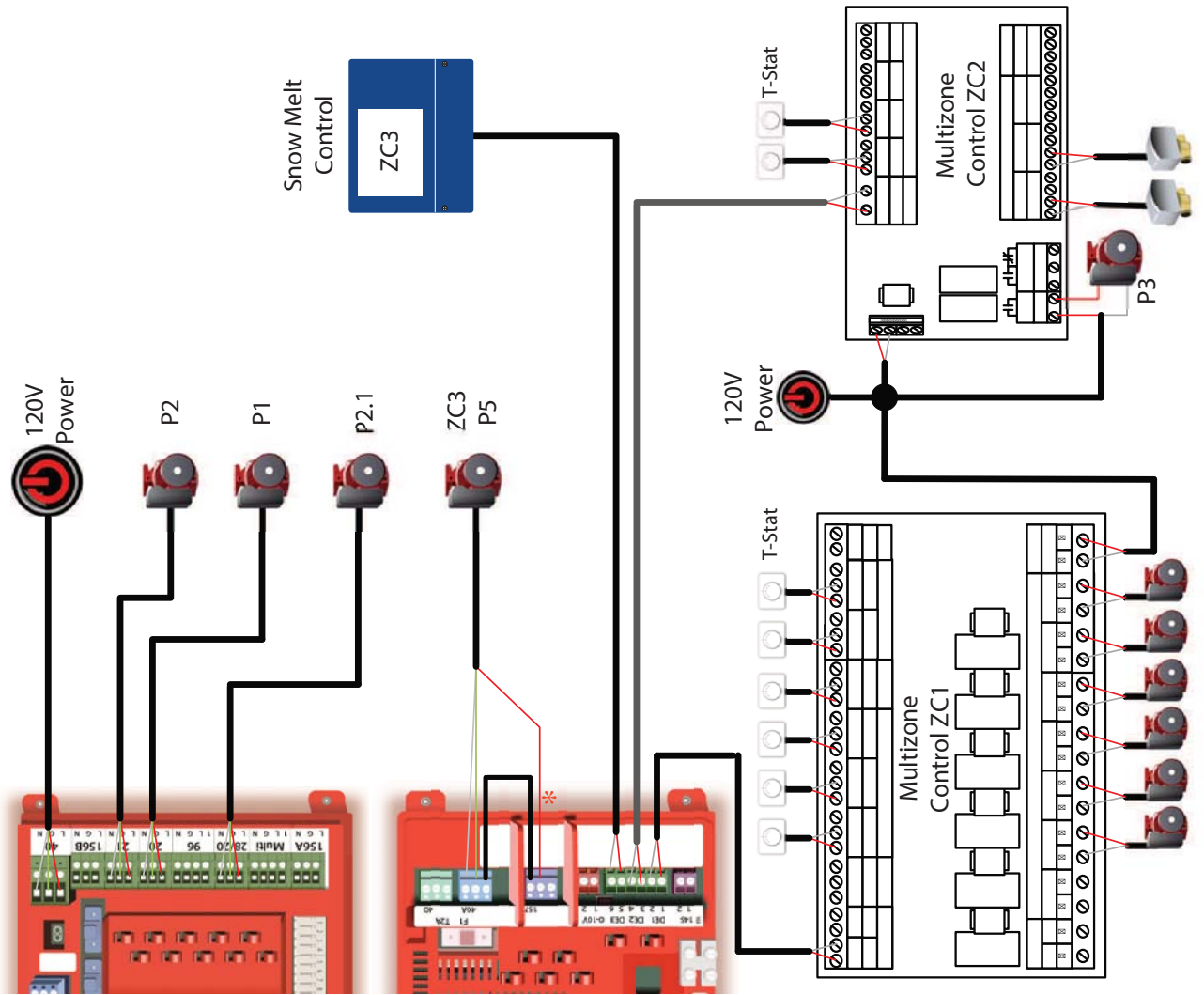

 Application Code
VD2I 3ZC9C.01

 Notes / Comments

1. Jumper must be installed between the 40A plug and the 157 Plug. (*)
2. When there are demand for multiple temperatures, the boiler will target the highest of the requested temperatures.

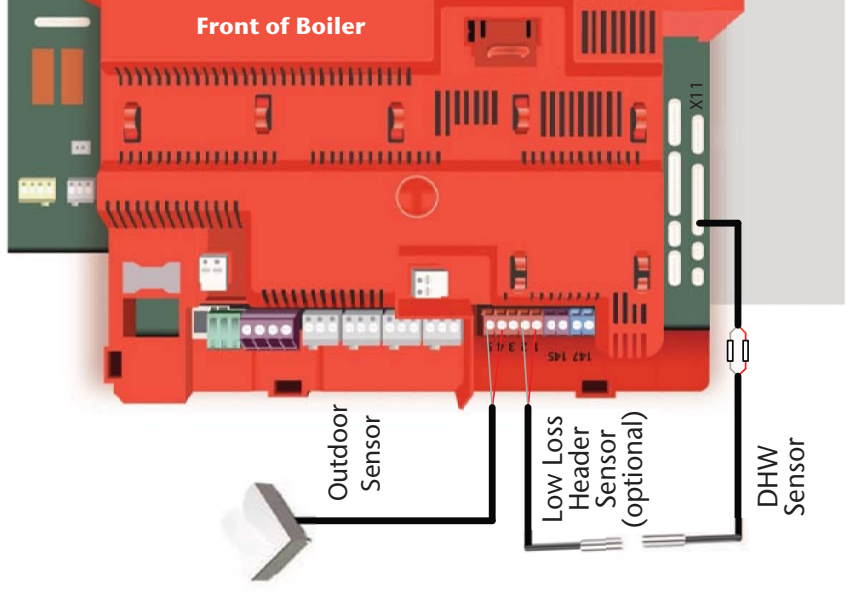

Zone Control Wizard—3 ZC—ZC1 Setpoint Demand with ZC2 Weather Compensated

This application shows 3 heating circuits, where a combination of pumps, zone valves and two types of call for heat are utilized. The ZC1 demand input comes from a Multizone Control which is responsible for accepting thermostat calls where a respective pump is enabled. The ZC1 is also configured for a Weather Compensated function which allows a zone set point to be calculated based on the slope and shift settings. The ZC2 input from the second Multizone Control is configured for a Fixed Setpoint where there is a call. This Multizone Control is responsible for controlling 2 zone valves based on the 2 thermostats. Lastly, ZC3 input comes from a snow melt control. The ZC3 is also configured to provide pump control on the 157 plug output.

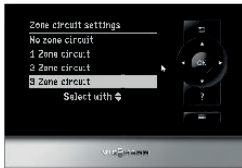

Select the correct number of Zone Circuit connections with respect to the number of controls connected to the DE connections. Press OK



This application is based on a Weather Compensated for ZC1. Arrow down and press OK to confirm setting.



The Slope and Shift settings can be adjusted to allow a heating curve to be set. When there is a zone heat demand, the calculated set point will be used as long as the demand is present. Arrow up or down to move to the shift setting from slope. Making an adjustment of either setting will graphically indicate how the heating curve moves.



Once the settings have been made, press OK to continue. These settings can be easily adjusted later on should they need to be changed.



There is no pump associated with ZC1 for this particular application. OK continues to the ZC2 circuit.



The Zone Circuit 2 is to be set for Fixed Setpoint temperature demand. Press OK to select and continue.



The next screen allows for a set point adjustment of the zone target temperature



The Zone Circuit 3 as shown below is to be set for Fixed Setpoint temperature demand. Press OK to select and continue. The next screen allows for a set point adjustment of the zone target temperature and lastly the selection of the 157 pump output.





Notes/Comments

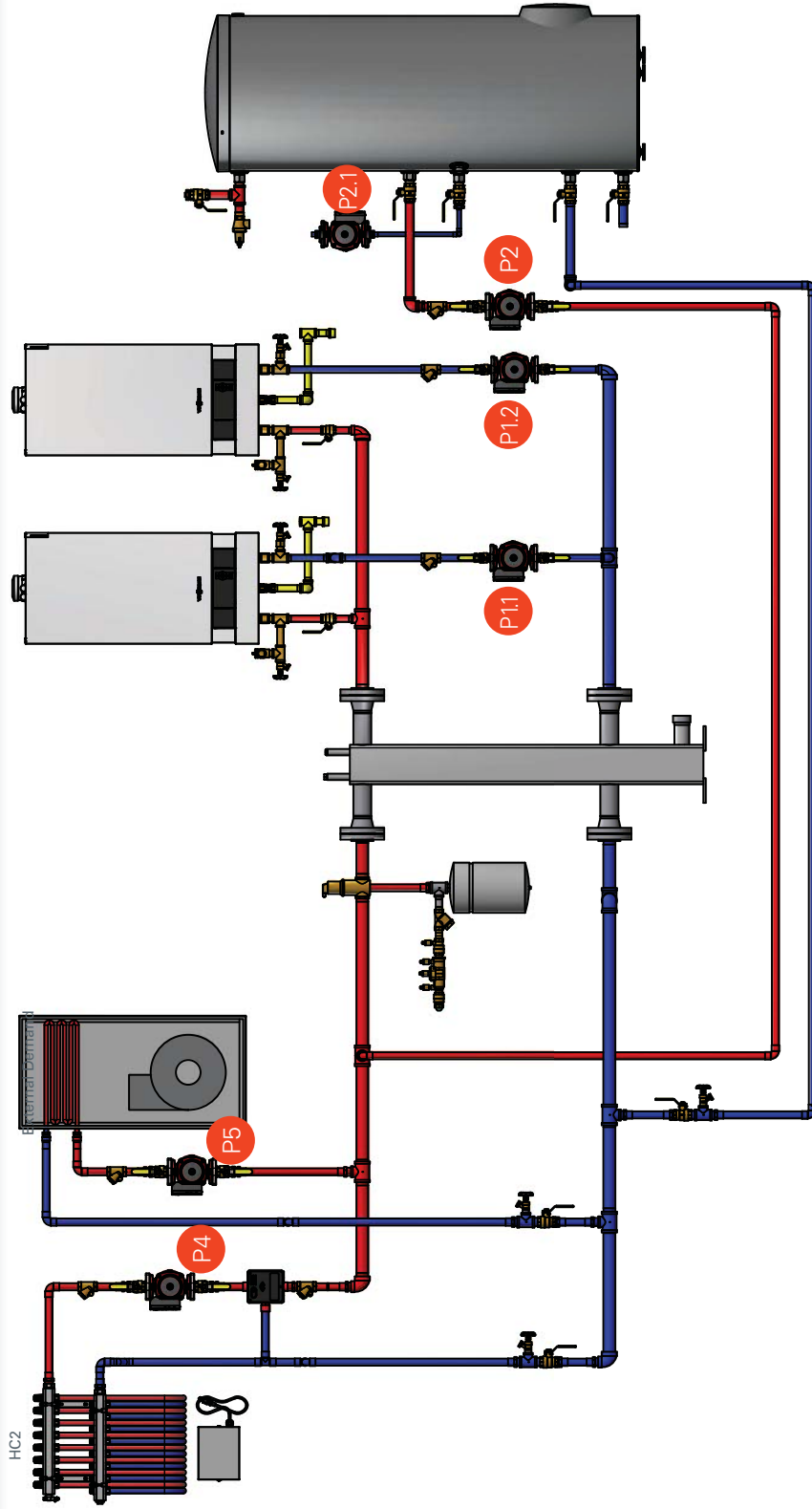

Notes / Comments

1. Component Index on pages 5.
2. Since the circulator in the air handler is not controlled by the boiler, higher than design water temperatures may reach the air handler when the DHW is calling for heat.



Pressure Drop / Pump Sizing

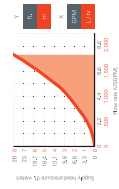

Vitodens 200-W
B2HB 19-57

Page
19 & 20

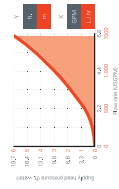

Vitodens 200-W
B2HA 80-150

Page
21 & 22



Application Code

2VD2I 3HC/ZC3ZP.01

 Application Code
2VD21 3HC/ZC3ZP:01

 Notes / Comments

1. Max amp load of the cascade control is 6 amps. Therefore, if using multiple circulators and mixing valve motors, isolation relays may be required.
2. P5 is internally controlled by the air handler.
3. Stroke direction of the mixing valve motor should be verified by an actuator test. (Refer to the Installation & Service Manual of the Cascade Control)

Boiler #1

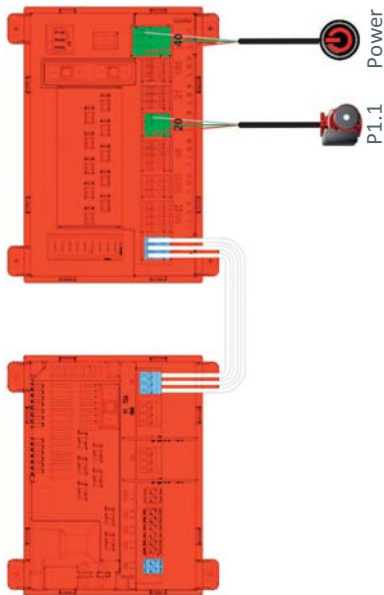

Boiler #2

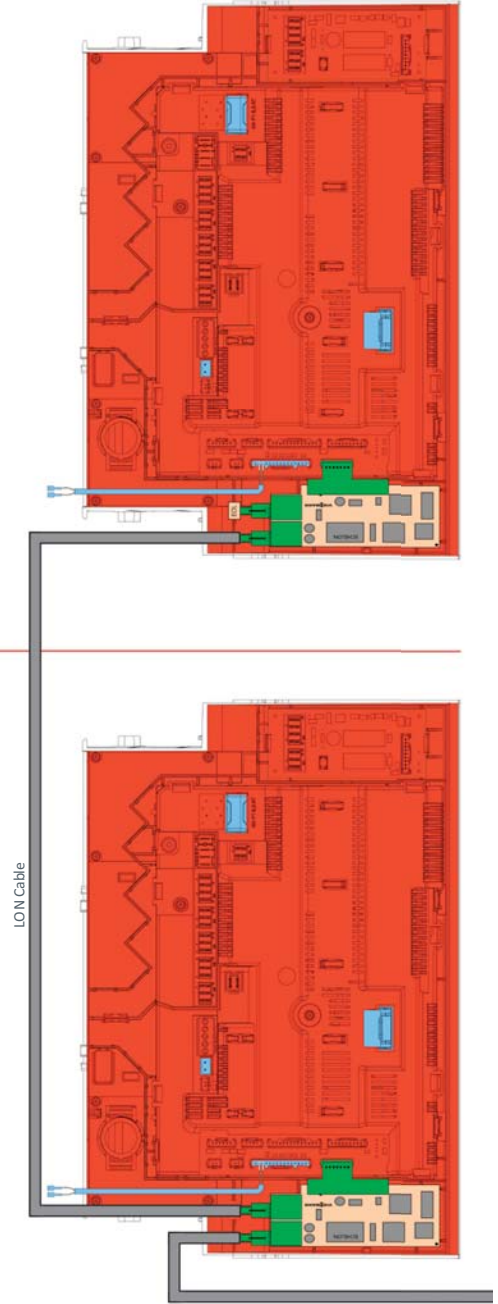
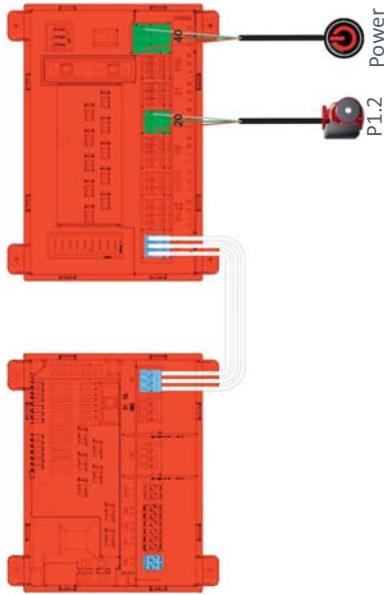



Application Code

2VD21 3HC/ZC3ZP01



Notes / Comments

1. Max amp load of the cascade control is 6 amps. Therefore, if using multiple circulators and mixing valve motors, isolation relays may be required.
2. P5 is internally controlled by the air handler.
3. Stroke direction of the mixing valve motor should be verified by an actuator test. (Refer to the Installation & Service Manual of the Cascade Control)

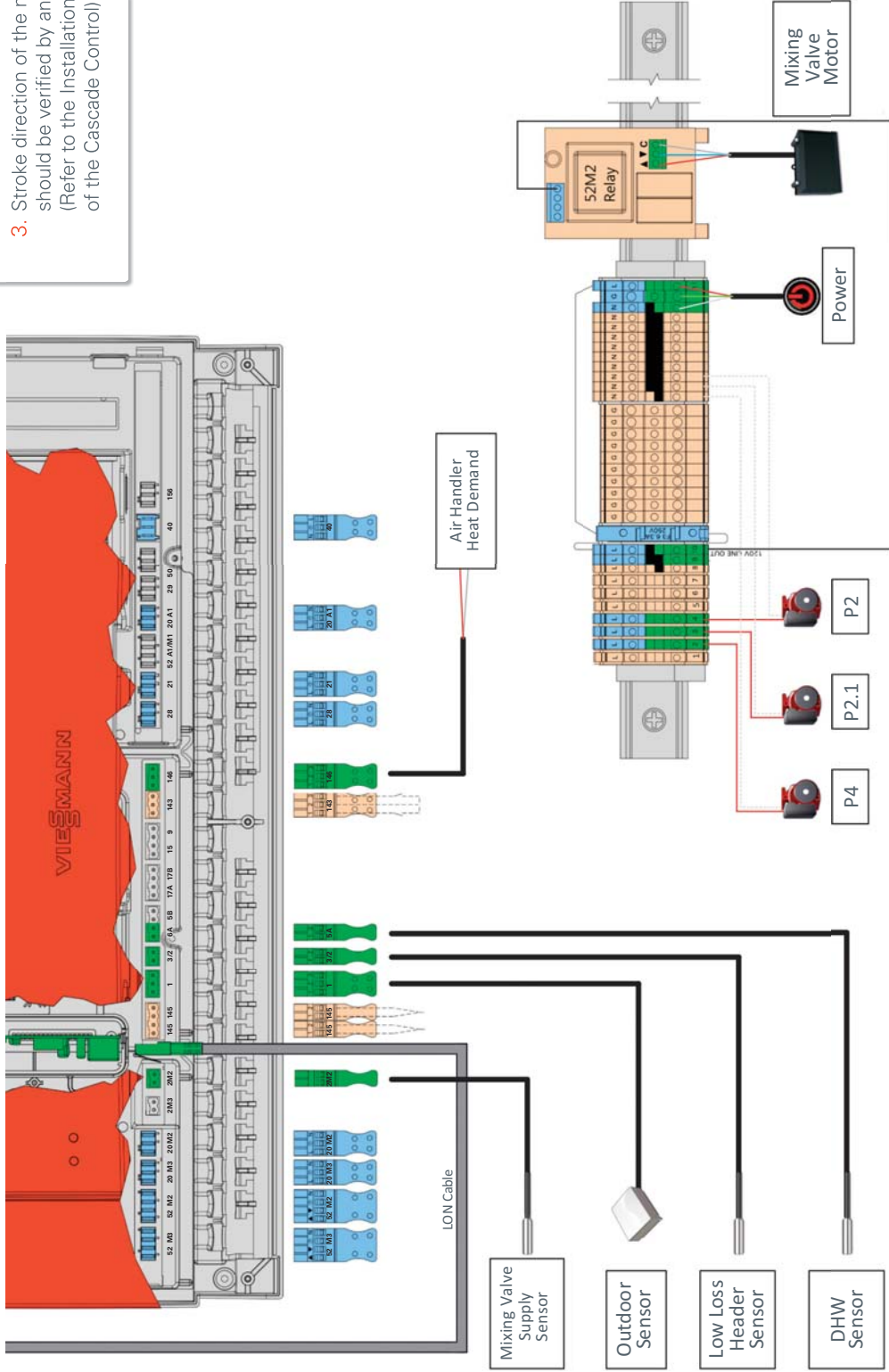

Application 8 Operational Setup Instructions

This application consists of a low temperature heat circuit with motorized mixing valve, a hot water forced air fan coil, indirect DHW and a 2-boiler cascade separated by a low loss header. This multi-boiler configuration offers greater flexibility in system design as it allows for increased system turndown, boiler redundancy, increased BTU inputs, and simultaneous operation of the heating and DHW. As the cascade control targets the maximum temperature for the system, the mixing valve offers the added benefit of automatically adjusting the supply water temperature regardless of the water temperatures being supplied to the other heat circuits. Since this is all controlled by the cascade control, this makes for a simple, long lasting and efficient system. To set up this system, follow the steps below:

Type/Option	Step#	Description	Parameter	Set to:	Setup Location
Setup on each boiler	1	Set to multi-boiler mode	Service Function -> Select Multiboiler Application		Service Menu
	2	Set boiler number	07:	Set Boiler #	Set in Level 2 Coding
	3	Set LON participant number	77:	Set Boiler #	
	4	Disable VS pump control	30	:00	
Setup On Cascade Control	5	Complete participant check (For further instruction, refer to Installation & Service Manual)			Service Menu
	6	Select system type	00	:04	Set in Level 2 Coding
	7	Set supply temperature of external demand	9B	Set Temp.	
	8	Set up HC2 outdoor reset curve			Set In Heating Sub Menu
	9	Set DHW temperature			

Optional Adjustments

Set a Heating Schedule	Set In Heating Sub Menu
Set a DHW Schedule	
Set a DHW Recirculation Schedule for P2.1	



Notes/Comments

- To enter service menu on the boiler you must hold the "OK" and buttons for 5 seconds.
- Setup wizard for the boilers and cascade controls must be completed before proceeding with any additional configurations.
- To enter the service level of the cascade control, press on the menu icon, select Service, and input the following password: viservice.

To proceed to level 2 coding, select system configuration icon, select coding 2 and input the following password: viexpert

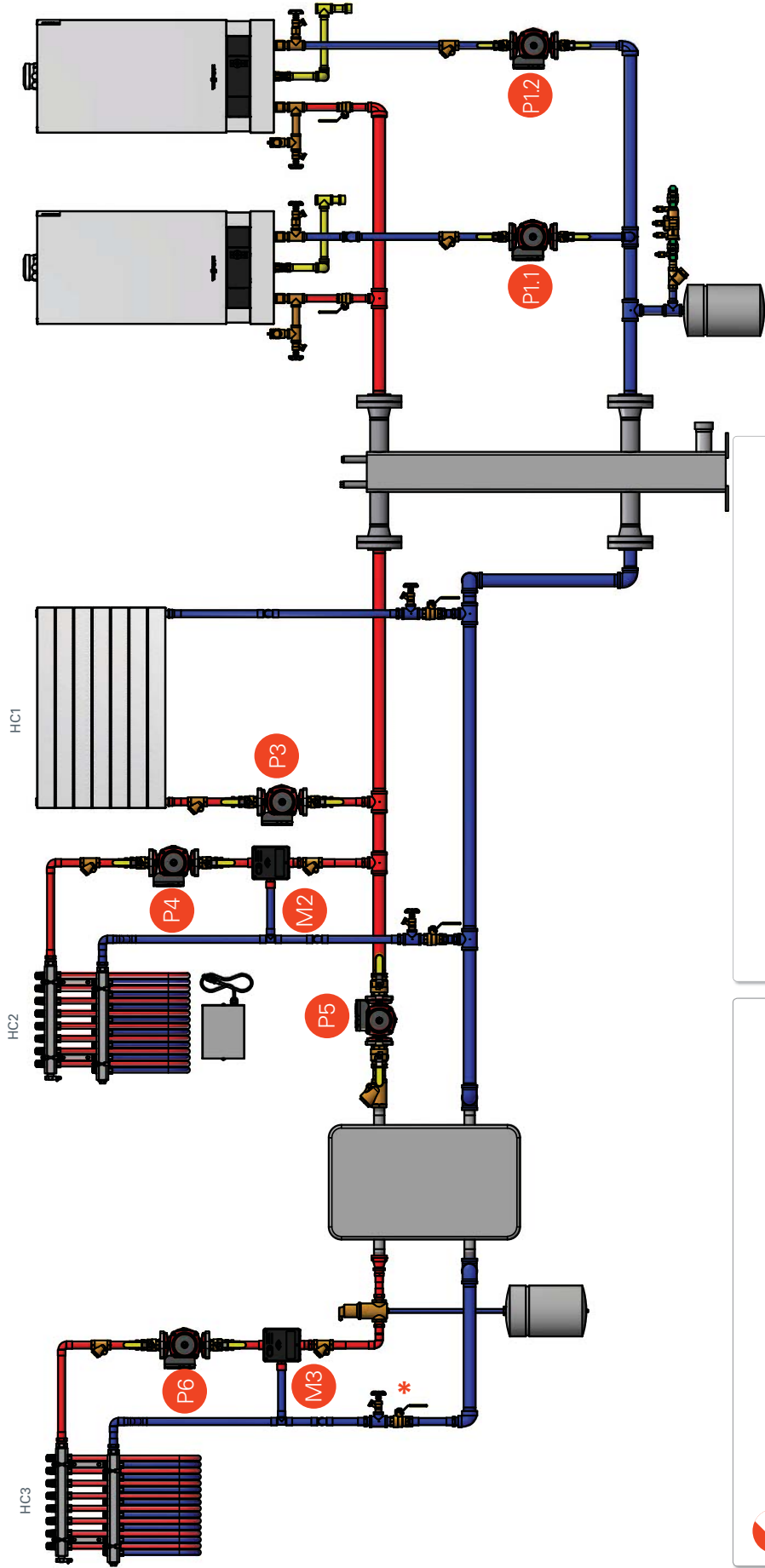

Notes / Comments

1. Component Index on pages 5.
2. External flow check valves are not necessary if built into the circulators.
3. Since HC3 is separated from the system via a heat exchanger, an automatic fluid feeder may be desired.
4. Based on recommended piping practices, a pressure relief valve should be installed on the secondary side of the heat exchanger.*



Pressure Drop / Pump Sizing

Page

19 & 20

Vitodens 200-W
B2HB 19-57

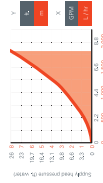

21 & 22

Vitodens 200-W
B2HA 80-150

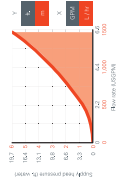

Application Code

2VD2X 3HC3ZP.01



Application Code

2VD2X 3HC3ZP01



Notes / Comments

1. Max amp load of the cascade control is 6 amps. Therefore, if using multiple circulators and mixing valve motors, isolation relays may be required.
2. Stroke direction of the mixing valve motors should be verified by an actuator test. Refer to the Installation and Service Manual of the Cascade Control.

Boiler #1

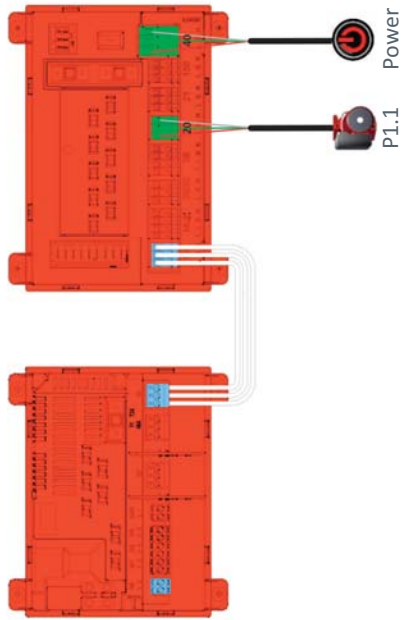

Boiler #2

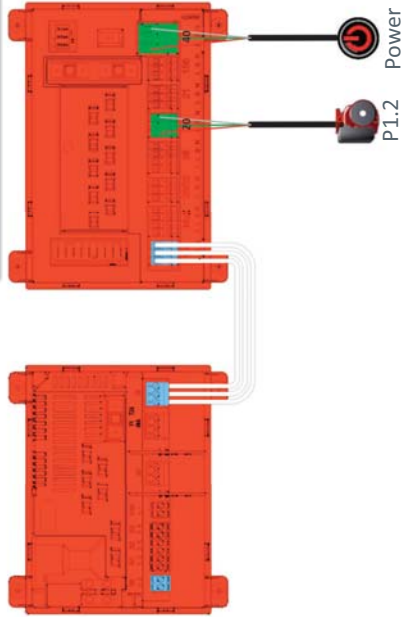

LON Cable

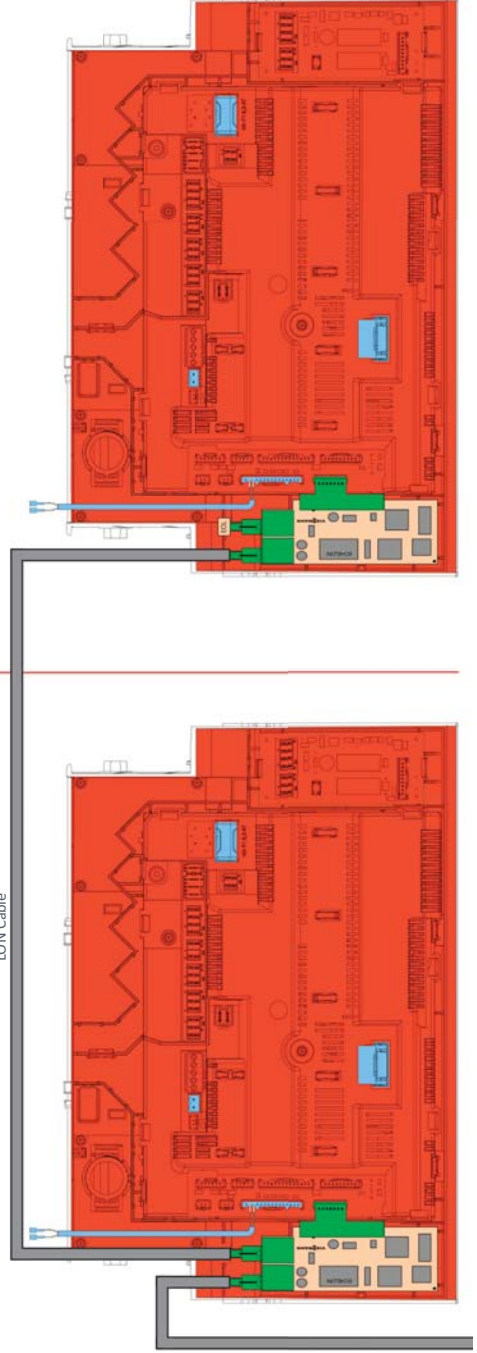

Application Code
2VD2X 3HC3ZP:01

Notes / Comments

1. Max amp load of the cascade control is 6 amps. Therefore, if using multiple circulators and mixing valve motors, isolation relays may be required.
2. Stroke direction of the mixing valve motors should be verified by an actuator test. Refer to the Installation and Service Manual of the Cascade Control.

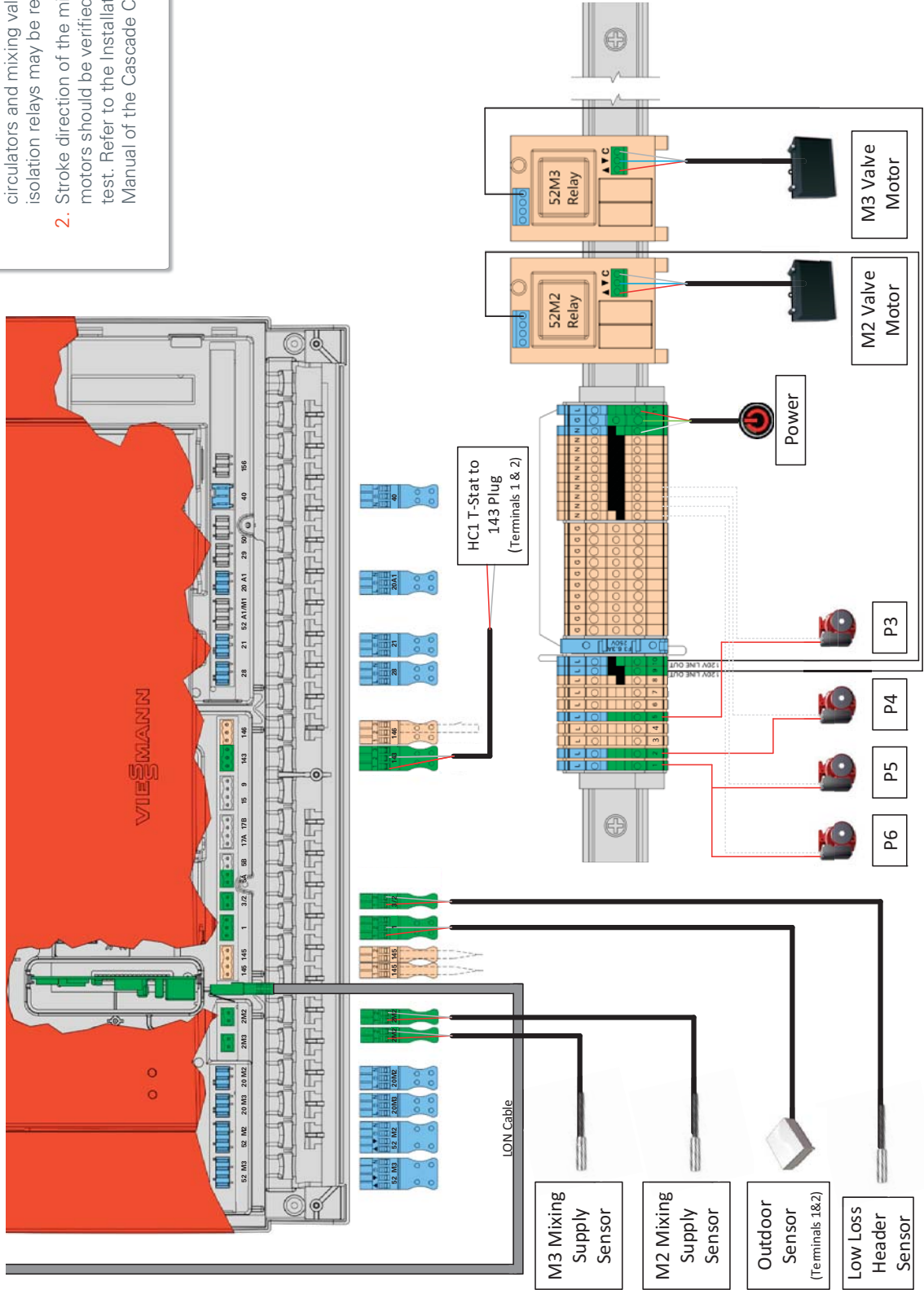

Application 9 Operational Setup Instructions

This application consists of a mid-temperature heat circuit, a low temperature heat circuit with motorized mixing valve, and a low temperature heat circuit with heat exchanger and mixing valve. This application is conducive to systems in which glycol must be incorporated for safety purposes. This multi-boiler configuration offers greater flexibility in system design as it allows for increased system turndown, boiler redundancy, increased BTU inputs, and simultaneous operation of the heating and DHW. As the cascade control targets the maximum temperature for the system, the mixing valves offer the added benefit of automatically adjusting the supply water temperature regardless of the water temperatures being supplied to the other heat circuits. Since this is all controlled by the cascade control, this makes for a simple, long lasting and efficient system. To set up this system, follow the steps below:

Type/Option	Step#	Description	Parameter	Set to:	Setup Location
Setup on each boiler	1	Set to multi-boiler mode	Service Function -> Select Multiboiler Application		Service Menu
	2	Set boiler number	07:	Set Boiler #	Set in Level 2 Coding
	3	Set LON participant number	77:	Set Boiler #	
	4	Disable VS pump control	30	:00	
Setup On Cascade Control	5	Complete participant check (For further instruction, refer to Installation & Service Manual)			Service Menu
	6	Assign thermostat to HC1	91	:01	Set in Level 2 Coding
	7	Remove pump post purge	F2	:00	
	8	Setup HC1 outdoor reset curve			Set In Heating Sub Menu
	9	Setup HC2 outdoor reset curve			
	10	Setup HC3 outdoor reset curve			
	11	Adjust HC1 heating schedule	--:--		

Optional Adjustments

Set a Heating Schedule	Set In Heating Sub Menu
Set a DHW Schedule	
Set a DHW Recirculation Schedule for P2.1	



Notes/Comments

- To enter service menu on the boiler you must hold the "OK" and buttons for 5 seconds.
- Setup wizard for the boilers and cascade controls must be completed before proceeding with any additional configurations.
- To enter the service level of the cascade control, press on the menu icon, select Service, and input the following password: viservice
To proceed to level 2 coding, select system configuration icon, select coding 2 and input the following password: viexpert

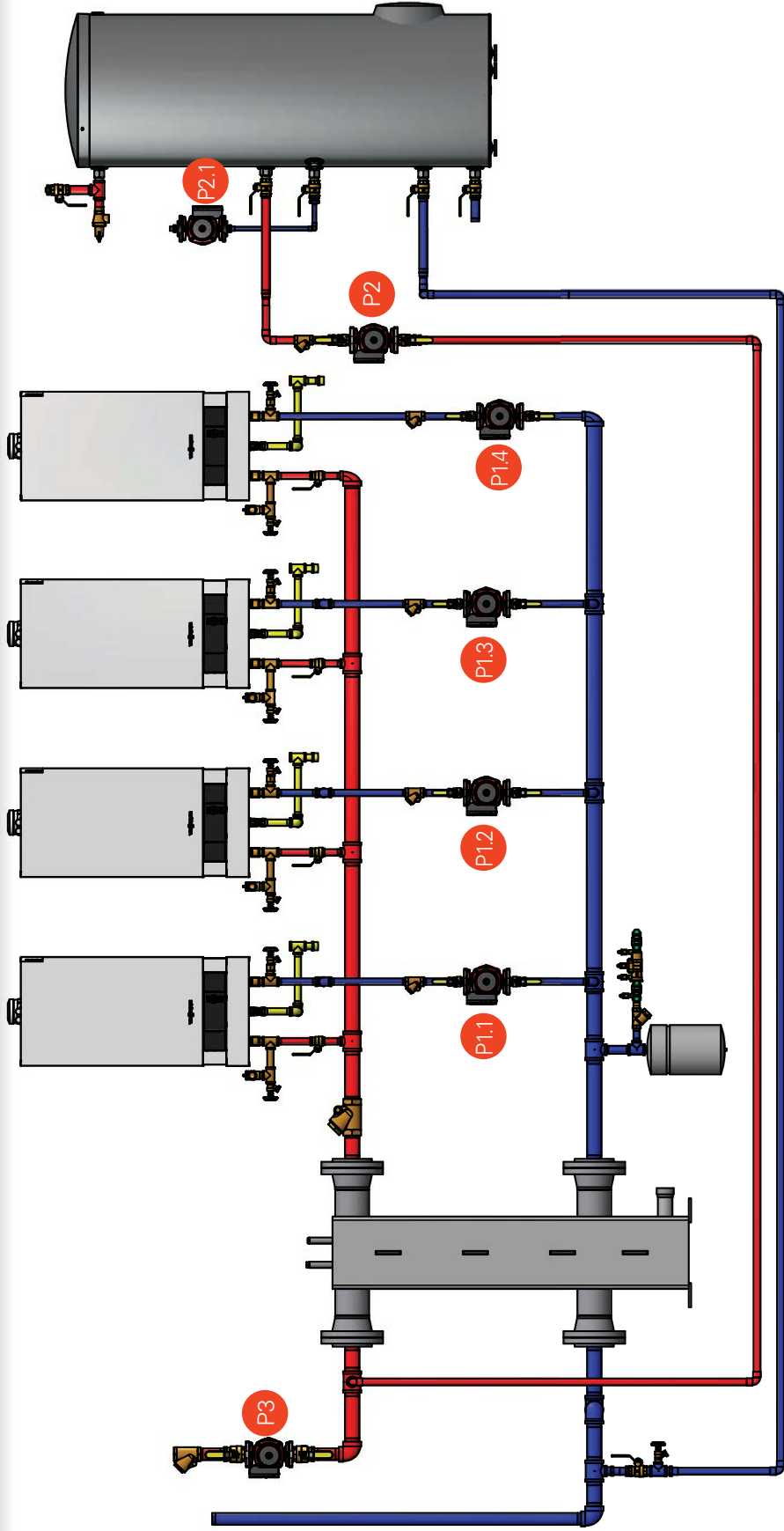

Notes / Comments

1. Component Index on pages 5.
2. External flow check valves are not necessary if integrated into the circulators.



Pressure Drop / Pump Sizing

Page
19 & 20

Vitodens 200-W
B2HB 19-57

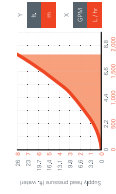

Page
21 & 22

Vitodens 200-W
B2HA 80-150

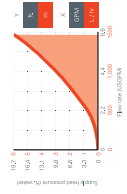

Application Code

4VD2I 2HC2ZP.01

 Application Code
4VD21 2HC2ZP01

 Notes / Comments

1. Max amp load of the cascade control is 6 amps. Therefore, isolation relays may be required when current draw of field supplied components is exceeded.

Boiler #1

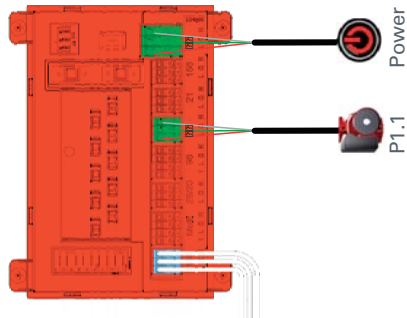

Boiler #2

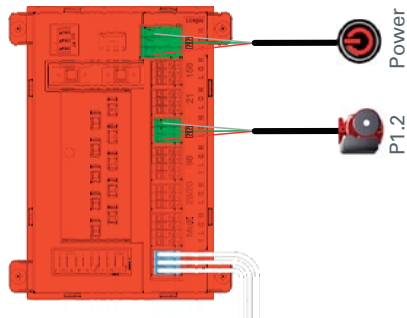

Boiler #3

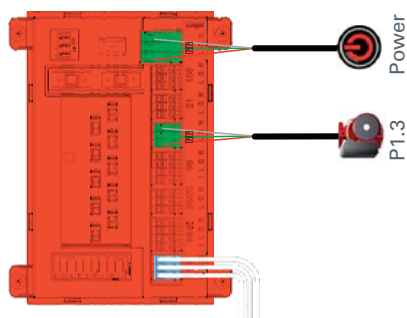

Boiler #4

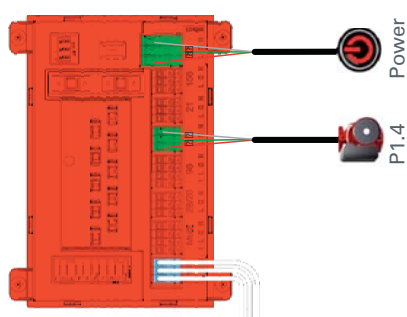

 Application Code
4VD21 2HC2ZR01

 Notes / Comments

1. Max amp load of the cascade control is 6 amps. Therefore, isolation relays may be required when current draw of field supplied components is exceeded.

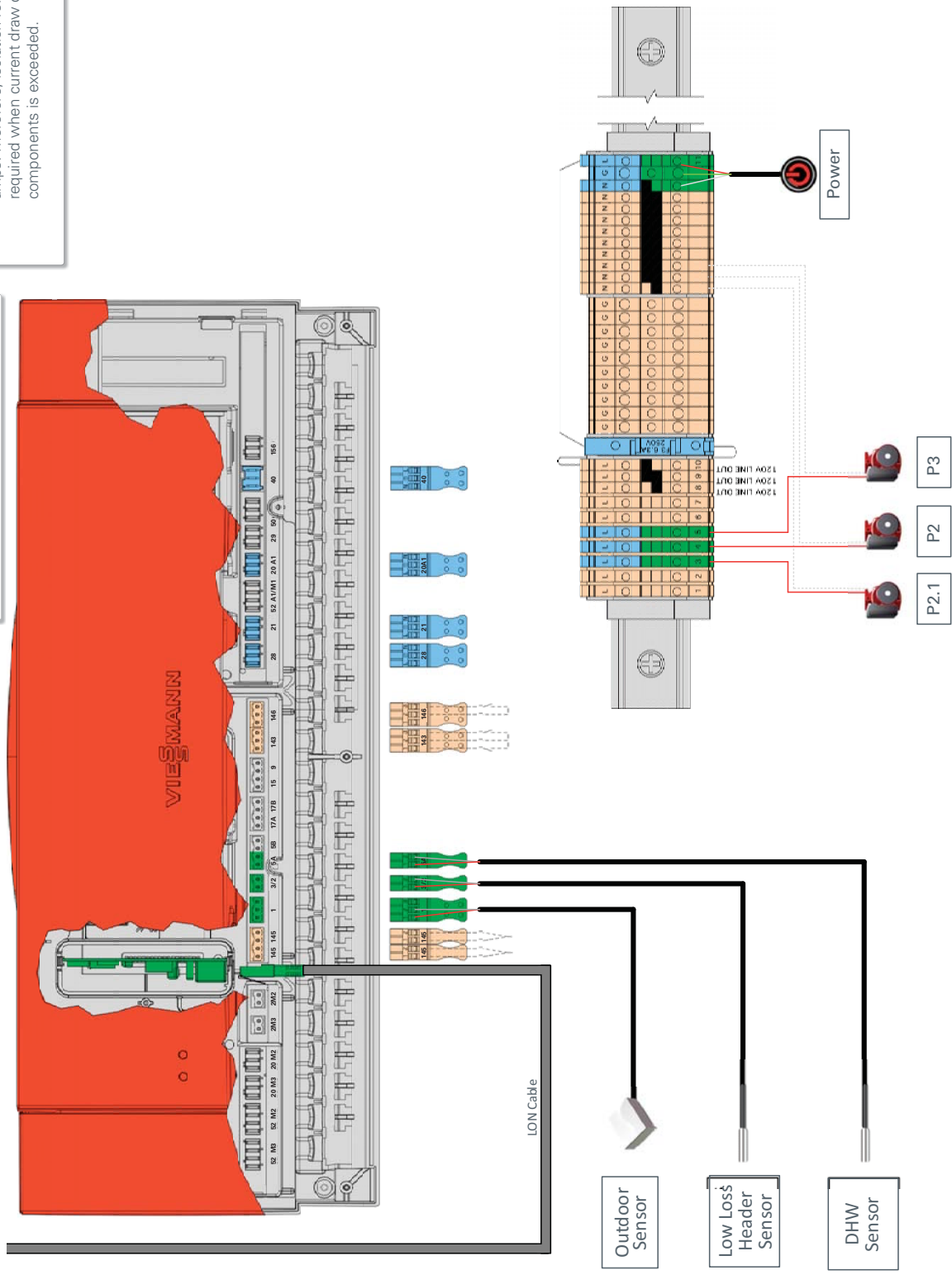

Application 10 Operational Setup Instructions

This application consists of a 4-boiler cascade, a single building loop and an indirect DHW. Designing a system in this way allows constant circulation of heated fluid throughout larger commercial buildings. This provides the ability to have unit specific heat emitters and controls to maximize the comfort within the building. The P3 circulator operates continuously until the outdoor temperature exceeds the warm weather shut down, at which time the boiler and circulators will all enter into a standby mode until the outdoor temperature drops or there is a demand for DHW. To set up this system, follow the steps below:

Type/Option	Step#	Description	Parameter	Set to:	Setup Location
Setup on each boiler	1	Set to multi-boiler mode	Service Function -> Select Multiboiler Application		Service Menu
	2	Set boiler number	07:	Set Boiler #	Set in Level 2 Coding
	3	Set LON participant number	77:	Set Boiler #	
	4	Disable VS pump control	30	:00	
Setup On Cascade Control	5	Complete participant check (For further instruction, refer to Installation & Service Manual)			Service Menu
	8	Setup HC1 outdoor reset curve			Set In Heating Sub Menu
	9	Set DHW temperature			
	11	Adjust HC1 heating schedule	--:--		
Optional Adjustments					
Set a Heating Schedule					Set In Heating Sub Menu
Set a DHW Schedule					
Set a DHW Recirculation Schedule for P2.1					



Notes/Comments

- To enter service menu on the boiler you must hold the "OK" and buttons for 5 seconds.
- Setup wizard for the boilers and cascade controls must be completed before proceeding with any additional configurations.
- To enter the service level of the cascade control, press on the menu icon, select Service, and input the following password: viservice
To proceed to level 2 coding, select system configuration icon, select coding 2 and input the following password: viexpert

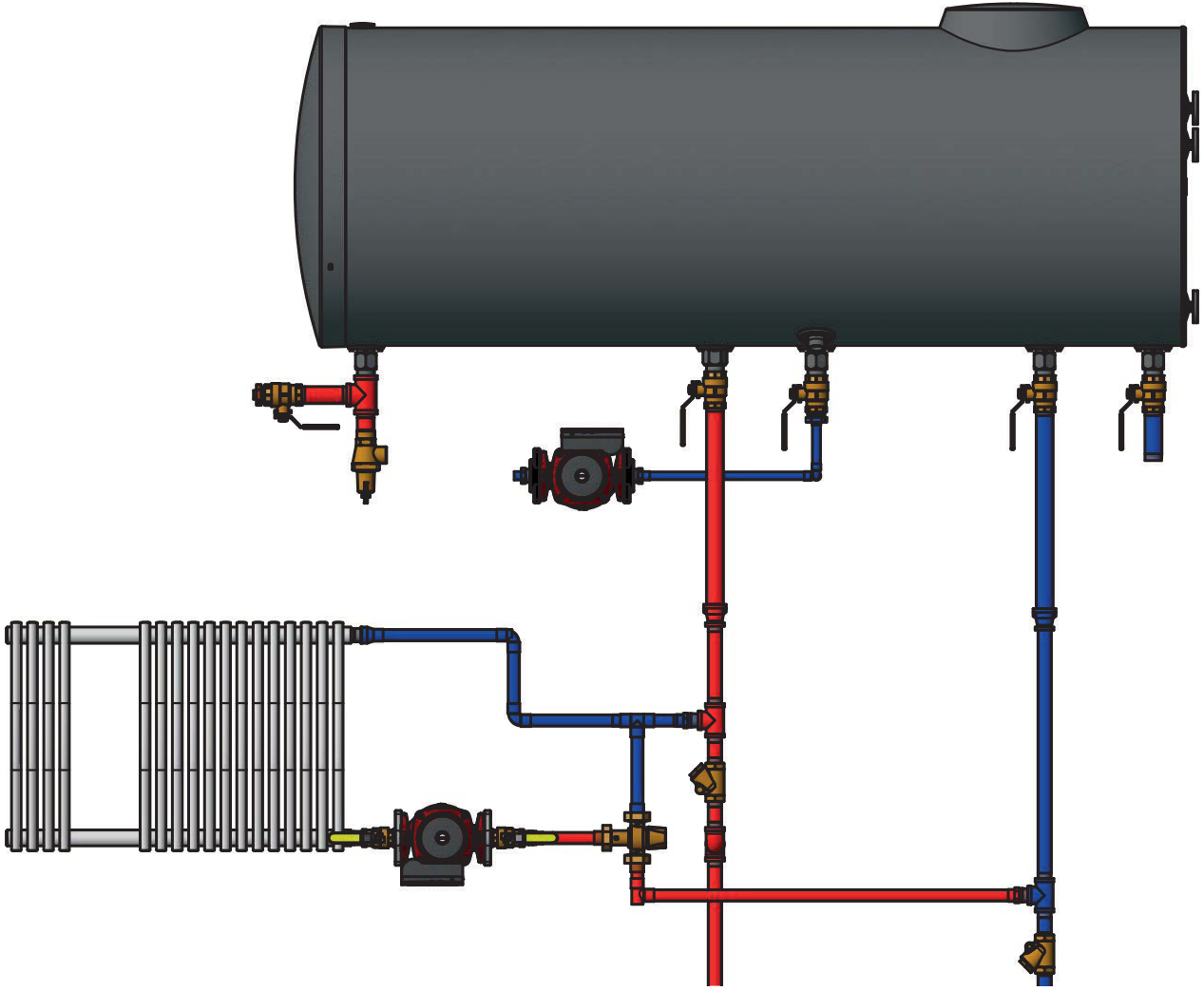

Application Code

Microload



Notes/Comments

1. Component Index on pages 5.
2. To ensure correct operation, install flow check valves according to this diagram

What is a Microload?

A Microload is typically considered a zone that has an output substantially less than the boilers lowest firing rate. Even when firing at its lowest input, the boiler will short cycle putting added stress on all the components and decreasing efficiency.



Application Code

Microload

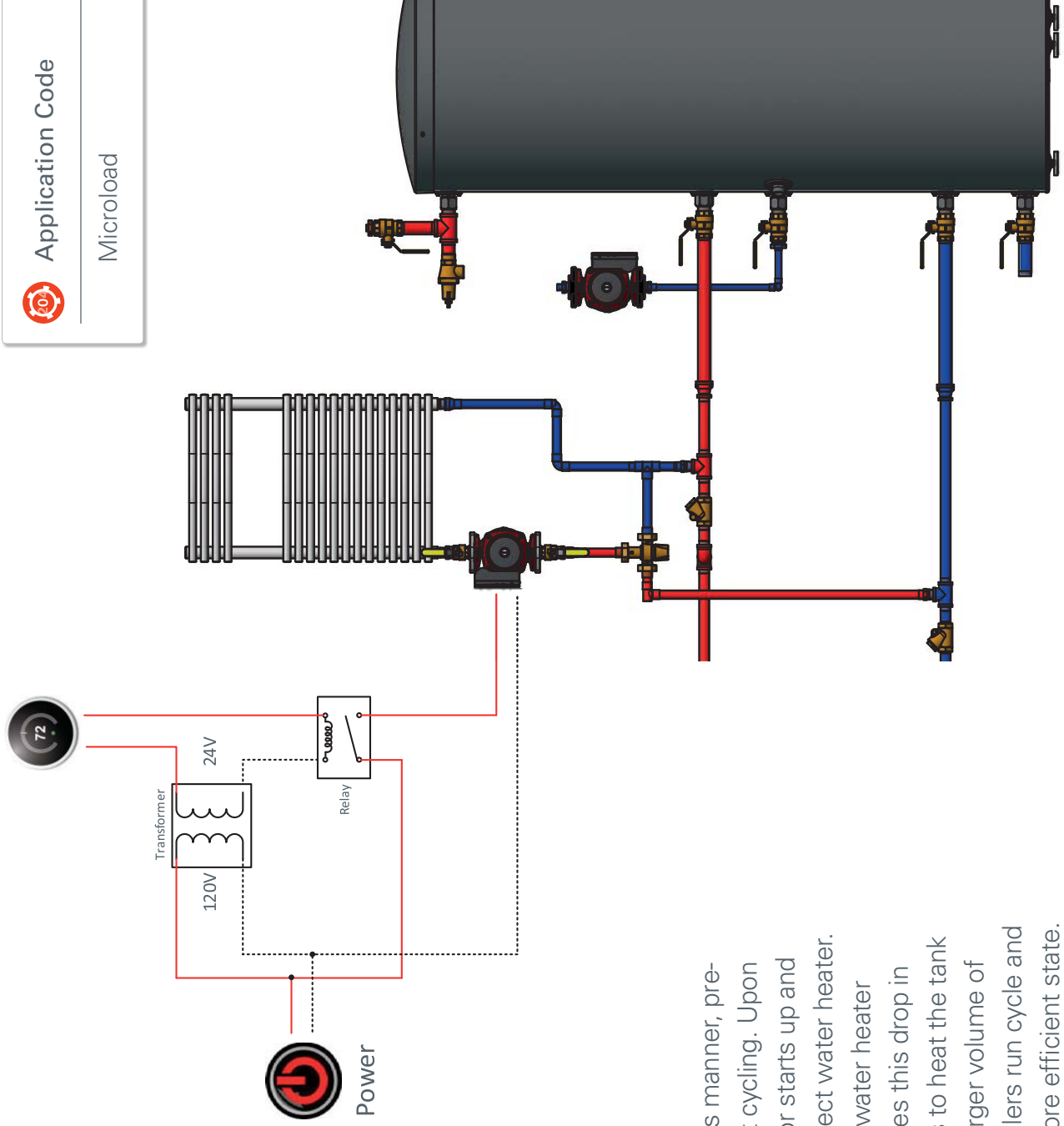

Solution

Piping a “Microload” in this manner, prevents the boiler from short cycling. Upon a call for heat, the circulator starts up and draws heat out of the indirect water heater. As the temperature in the water heater decreases, the boiler senses this drop in temperature and proceeds to heat the tank back up. Because of the larger volume of water, this extends the boilers run cycle and allows it to operate at a more efficient state.

Application Rules & Formulas

Universal Hydronics Formula:

$$\text{GPM} = \frac{\text{BTUH}}{500 \times \Delta T} \quad \text{BTUH} = \text{GPM} \times 500 \times \Delta T$$

Piping & Tubing Properties

Steel/Wrought Iron Pipe

Size	Content/ft (gal)	Max Flow Rate ¹ (GPM)	Max Heat Carrying Capability (BTUH) ²
1/2"	.016	4	40,000
3/4"	.028	7	70,000
1"	.045	12	120,000
1-1/4"	.078	20	200,000
1-1/2"	.106	28	280,000
2"	.174	44	440,000

*Based on a velocity of 4fpm

*Based on 20°F ΔT

Pex Tubing

Size	Content/ft (gal)	Max Flow Rate ¹ (GPM)	Max Heat Carrying Capability (BTUH) ²
1/2"	.009	2.3	23,000
5/8"	.013	3.3	33,000
3/4"	.018	4.6	46,000
1"	.030	7.5	75,000
1-1/4"	.046	11.2	112,000
1-1/2"	.105	15.6	156,000

*Based on a velocity of 4fpm

*Based on 20°F ΔT

Copper Tubing (Type L)

Size	Content/ft (gal)	Max Flow Rate ¹ (GPM)	Max Heat Carrying Capability (BTUH) ²
3/8"	.007	2	20,000
1/2"	.012	3.2	32,000
3/4"	.025	6.5	65,000
1"	.043	10.9	109,000
1-1/4"	.065	16.3	163,000
1-1/2"	.092	22.9	229,000
2"	.161	39.6	396,000

*Based on a velocity of 4fpm

*Based on 20°F ΔT

Quick Pipe Resistance Calculation:

1. Measure longest run of pipe
 2. Add 50% for fittings
 3. Multiply by .04
- = A rough calculation on the feet of head the pump needs to overcome for that circuit.

Radiant Sizing:

Estimating Radiant Tubing

6" OC Qty = FT² of space x 2

12" OC Qty = FT² of space x 1.2

Estimating BTUH for Radiant

Floor Warming = 15-20 btuh/ft

Floor Heating = 35-50 btuh/ft

Expansion Tank Quick Sizer

Boiler Output	Finned Baseboard	Air Handler/ Unit Heater	Cast Radiator	Cast Iron Baseboard
25,000	15	15	15	15
50,000	15	15	30	30
75,000	30	30	30	60
100,000	30	30	60	60
125,000	30	60	60	90
150,000	30	60	90	90
175,000	60	60	30V	30V
200,000	60	90	30V	30V
250,000	60	90	30V	40V
300,000	90	30V	30V	40V

Buffer Tank Sizing

Minimum

Tank = Boiler Run Time x (Min Boiler Firing Rate - Smallest Zone)

Volume = 500 x ΔT

Pool Sizing

Pool Capacity (gallons):

Circular Pool = Avg. Depth x Diameter² x 5.9

Rectangular Pool = Avg. Depth x Length x Width x 7.5

BTUH Requirement:

$$\text{BTUH} = \frac{\text{Pool Capacity} \times 8.34 \times \text{Temp Rise}}{\text{Hours to Heat Pool}}$$

Temp. Difference between pool temp and ambient air temp (°F)	10°	15°	20°	25°	30°
BTUH/Ft ²	105	158	210	263	368

This is Viessmann

The Viessmann Group is one of the world's leading manufacturers of heating and renewable energy systems. Family-owned since 1917, Prof. Dr. Martin Viessmann leads the company in its third generation. The group today employs over 11,400 employees worldwide and has a turnover of approx. 2.1 billion Euro. 27 manufacturing facilities in 11 countries, sales & distribution facilities in Germany and 74 other countries, and 120 sales offices worldwide provide customer proximity and a strong global presence. For three generations, Viessmann has been providing comfortable, efficient and environmentally-responsible heating solutions, tailored to the needs of the market. With ongoing research and development and a focus on product innovation, Viessmann has pioneered technologies that have continuously set standards and made the company into a technological innovator and pacesetter of the entire industry.

With the current comprehensive product range, Viessmann is offering a multi-level program of high-tech, state-of-the-art heating products. Wall-mounted gas-fired condensing boilers, floor-standing oil – or gas-fired hot water heating boilers, solar thermal systems, control technology

and DHW storage tanks – all designed to achieve superior performance, reliability and energy savings.

Accountability for the environment and society, fairness when dealing with business partners as well as the pursuit of perfection and maximum efficiency in all business transactions are key values for Viessmann – as a company, and as individuals. This, together with the products and services we offer, allows us to offer our customers the benefit and added value of a strong brand.

Viessmann Manufacturing Company Inc.
750 McMurray Rd.
Waterloo, ON N2V 2G5, Canada
1-800-387-7373
info@viessmann.ca
www.viessmann.ca

Viessmann Manufacturing Company Inc.
6350 204th St.
Langley, BC V2Y 2V1, Canada
1-877-853-3288
info-bc@viessmann.ca
www.viessmann.ca

Viessmann Manufacturing Company Inc. USA
45 Access Rd.
Warwick, RI 02886, USA
1-800-288-0667
info@viessmann-us.com
www.viessmann.com

Global presence, local commitment.



Langley
British Columbia



Waterloo
Ontario



Warwick
Rhode Island



Viessmann Manufacturing
Company Inc.
Waterloo, ON Canada
1-800-387-7373
www.viessmann.ca

Viessmann Manufacturing
Company Inc. USA
Warwick, RI 02886, USA
1-800-288-0667
info@viessmann-us.com
www.viessmann.com